

FLEX^{NX}[®]

User Guide

MN73-362 Rev A

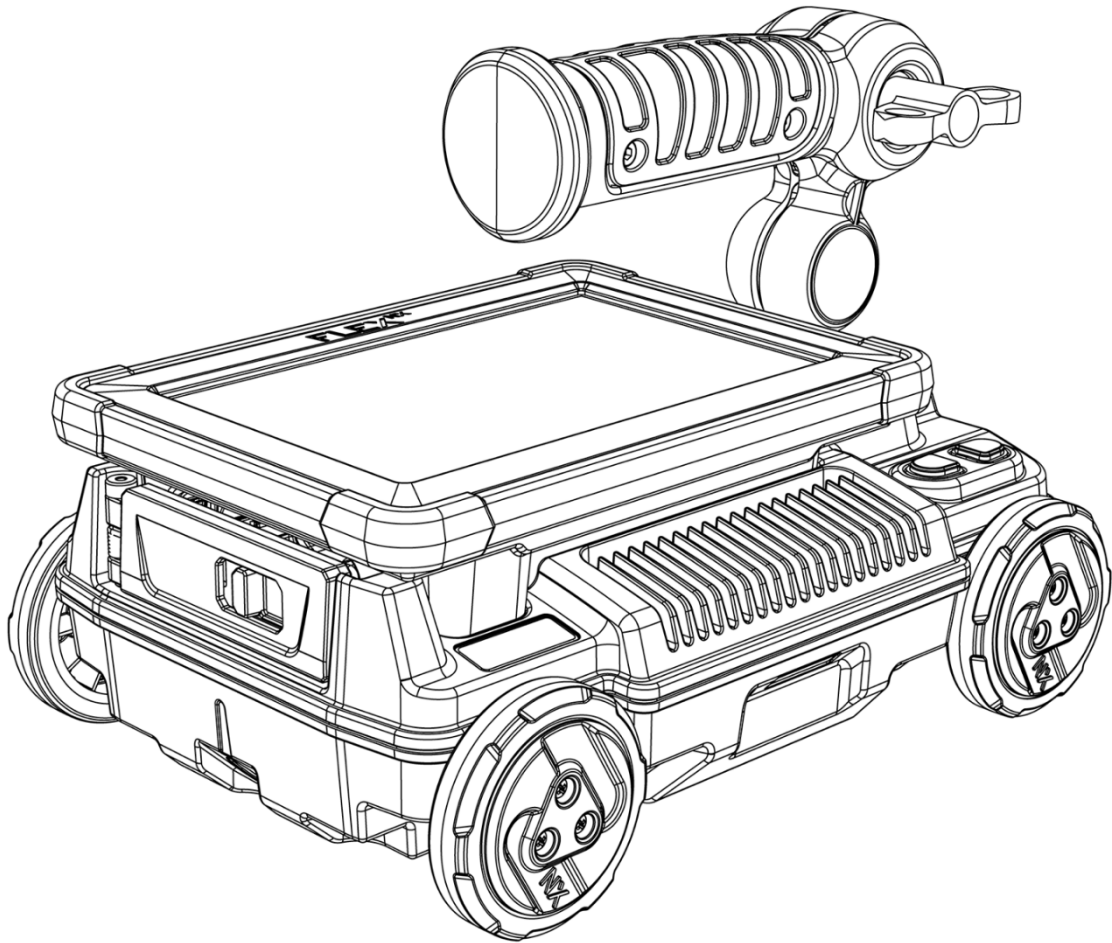

Geophysical Survey Systems Inc.

www.geophysical.com

Copyright © 2023 Geophysical Survey Systems, Inc.
All rights reserved
including the right of reproduction
in whole or in part in any form

Published by Geophysical Survey Systems, Inc.
40 Simon Street
Nashua, NH 03060-3075 USA

GSSI, Flex NX, Nexus, GSSI Fusion, RADAN, SIR, UtilityScan, PaveScan RDM are registered trademarks of Geophysical Survey Systems, Inc.

Limited Warranty, and Limitations of Liability and Restrictions

Geophysical Survey Systems, Inc. hereinafter referred to as GSSI, warrants that for a period of 24 months from the delivery date to the original purchaser this product will be free from defects in materials and workmanship. EXCEPT FOR THE FOREGOING LIMITED WARRANTY, GSSI DISCLAIMS ALL WARRANTIES, EXPRESS OR IMPLIED, INCLUDING ANY WARRANTY OF MERCHANTABILITY OR FITNESS FOR A PARTICULAR PURPOSE. GSSI's obligation is limited to repairing or replacing parts or equipment which are returned to GSSI, transportation and insurance pre-paid, without alteration or further damage, and which in GSSI's judgment were defective or became defective during normal use.

GSSI ASSUMES NO LIABILITY FOR ANY DIRECT, INDIRECT, SPECIAL, INCIDENTAL OR CONSEQUENTIAL DAMAGES OR INJURIES CAUSED BY PROPER OR IMPROPER OPERATION OF ITS EQUIPMENT, WHETHER OR NOT DEFECTIVE.

GPR UWB Compliance Notice

The FCC has granted Geophysical Survey Systems, Inc a waiver of sections 15.503(d), 15.31(c) and 15.521(d) rules, certifying the Flex NX system and its accessories for GPR UWB transmission. This action was adopted and released by the Chief of the Office of Engineering and Technology (OET) on 31 July 2023 and is described in waiver DA 23-650. This waiver is subject to the following conditions:

1. The GSSI GPR device was certified by an authorized Telecommunications Certification Body. A copy of Waiver DA 23-650 was submitted with the application for certification.
2. The Flex NX operates with stepped frequency CW modulation in 1-40 MHz steps between 30-6000 MHz
3. The Flex NX dwell time on any one frequency does not exceed 2 microseconds.
4. The dwell time during any step of the Flex NX does not exceed 0.04 percent of the device's minimum scan/cycle rate.
5. For certification testing, the measurement of emissions from the Flex NX was conducted with the stepping function active for all possible frequency step sizes.
6. The Flex NX complies with all other technical and operational requirements applicable to UWB GPR devices under Part 15, Subpart F of the Commission's rules.
7. Operation of the Flex NX is limited to GPRs and wall imaging systems operated for purposes associated with law enforcement, fire fighting, emergency rescue, scientific research, commercial mining, or construction. Parties operating this equipment must be eligible for licensing under the provisions of part 90 of § 15.509.
8. Sales of the GSSI GPR device authorized under this waiver are subject to an annual limit of 5,000 devices for each of the first two years and 10,000 devices each year thereafter.

The Flex NX is not a toy. The Flex NX cannot be used on ships or aircraft.

FCC Class A Compliance

This device complies with Part 15 of the FCC Rules. Operation is subject to the following two conditions: (1) this device may not cause harmful interference, and (2) this device must accept any interference received, including interference that may cause undesired operation.

Warning: Changes or modifications to this unit not expressly approved by the party responsible for compliance could void the user's authority to operate the equipment.

Note: This equipment has been tested and found to comply with the limits for a Class A digital device, pursuant to Part 15 of the FCC Rules. These limits are designed to provide reasonable protection against harmful interference when the equipment is operated in a commercial environment or residential installation. This equipment generates, uses, and can radiate radio frequency energy and, if not installed and used in accordance with the introduction manual, may cause harmful interference to radio communications. However, there is no guarantee that interference will not occur in a particular installation.

Canadian Emissions Requirements

This Class A digital apparatus complies with Canadian ICES-003.

Cet appareil numérique de la classe A est conforme à la norme NMB-003 du Canada.

Table of Contents

Limited Warranty, and Limitations of Liability and Restrictions
 GPR UWB Compliance Notice
 FCC Class A Compliance
 Canadian Emissions Requirements

Introduction.....	1
What’s in the Box.....	1
Optional Accessories.....	2
System Specifications.....	2
Comparison of Flex NX and StructureScan Mini XT	3
What is NEXUS™?	4
Flex NX and GSSI Fusion™	4
GPR Theory Overview	4
The Anatomy of a GPR Profile.....	5
Common GPR Uses in Concrete Scanning.....	8
Flex NX Hardware Overview.....	9
Handle Configurations.....	9
Touchscreen Display Care and Maintenance.....	9
Battery Usage.....	10
Powering On Flex NX and NX25 Satellite Antenna	11
Pairing Satellite Antennas	11
Using Two GPR Antennas: Standard and Cross-Polarized.....	12
Flex NX User Interface.....	14
Main Dashboard	14
System Settings.....	18
Date and Time Settings	19
NX 25 System Settings.....	20
Health Settings	20
Health Settings: Software Update	20
Health Settings: Updating Flex NX.....	21
Health Settings: Updating NX25	25
Health Settings: Log File Download.....	28
Connecting an External Viewing Device	29
Technical Support.....	32

Project Management.....	33
Projects Portal	33
Creating New Projects.....	33
Project Profile	35
Transferring Data.....	38
Wireless Transfer.....	40
USB Transfer.....	42
Collecting Data with Flex NX.....	44
Scanning and Marking Overview.....	44
Before You Scan.....	44
Data Screen and Basic Collection	46
Top Navigation Panel.....	48
Side Navigation.....	49
Side Navigation: Gain Panel.....	49
Side Navigation: Display Panel: Color Table Options Submenu	50
Side Navigation: Display Panel: Window Options Submenu.....	50
Side Navigation: Depth Panel	54
Target Marking.....	58
Additional Resources.....	59
GSSI Academy Training.....	59
Scanning and Marking Best Practices.....	59
Basic Scan and Mark Techniques.....	59
Data Examples	61
Wire Mesh.....	62
Rebar.....	64
Conduit	65
Pan Decking.....	66
Beams and Objects Strapped to the Slab.....	67
PVC vs. Metal Targets.....	68
Air Voids Under Concrete Slabs	69
Multiple Reinforcement Layers.....	70
PT Cables.....	71

Introduction

Thank you for purchasing Flex NX®, the new standard in concrete scanning. This manual covers the entire suite of product features and offers many useful tips on data collection and interpretation.

Our promise to you is to provide comprehensive training, unrivaled customer support and world-class expertise. That's why Flex NX includes our industry-leading two-year warranty, complimentary training, and technical support access. For more information, visit us at www.geophysical.com.



Our team of dedicated technical trainers is ready to work with users of all experience levels, and GSSI Academy classes are offered on an annual schedule. Check out the GSSI Academy offerings at www.geophysical.com/gssi-academy or scan the accompanying QR code with your smartphone.

What's in the Box

The standard Flex NX system ships with the following:

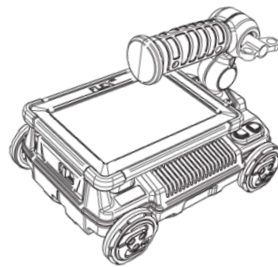

Flex NX Controller
Part #: **FGFLEX NX**

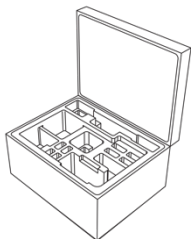

Flex NX Transit Case
Part #: **F-73-176**



Wrist Lanyard
Part #: **F-73-159**

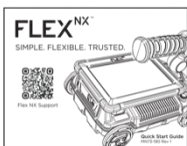

Quick Start Guide
Part #: **MN73-190**



Extra RAM® Mount
Part #: **RAM-238U**

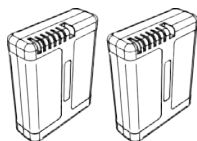

Lithium-Ion Battery (2X)
Part #: **FGNX-BAT-3 CELL**

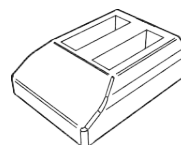

2-Bay Charger
Part #: **FGMODBC-NX**

Optional Accessories

The following accessories are available for Flex NX and are sold separately:

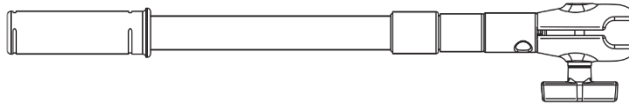

Telescoping Pole with RAM Grip for use with Flex NX and NX25
Part #: **FGNX-POLE**

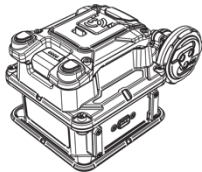

NX25 Satellite Antenna
Part #: **FGNX25**

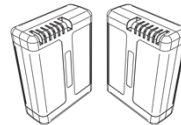

NX25 Lithium-Ion Battery
Part #: **FGNX-BAT-2 CELL**

System Specifications

Feature	Description
Unit Type	Self-contained all-in-one GPR system
Measuring Type	Ground Penetrating Radar (GPR)
Operational Modes	Single or dual channel (stacked) LineScan, Focus Mode*
Max Depth	Flex NX and NX25**: 0-75 cm (0-30 in)
Gain Mode	Configurable automatic gain
Dielectric Settings	Configured though concrete cure, manual entry, matching, set depth
Languages	English, Spanish, Japanese, Korean, Chinese, French
Display	178 mm (7 in) LED backlit LCD touchscreen display
Storage	200 GB
Operating Temperature	-20°C to +50°C (-4°F to +122°F)
Storage Temperature	-40°C to +60°C (-40°F to +140°F)
IP Rating	IP65 (fully sealed against dust, low-pressure omnidirectional water)
Battery Performance	Flex NX up to 3.5 hours, NX25** up to 6 hours in ideal conditions
Dimensions	Flex NX: 25.3 x 13.2 x 18.9 cm (9.9 x 5.2 x 7.4 in) NX25**: 11.2 x 11.2 x 10.4 cm (4.4 x 4.4 x 4.1 in)
Weight	Flex NX: 2.2 kg (4.9 lbs) with battery; 2.45 kg (5.3 lbs) with battery and handle; NX25**: 0.83kg (1.8lbs) with battery
Hardware Warranty	2 years from date of purchase

*Focus Mode will be released in a future software update

**NX25 satellite antenna sold separately, or as part of the Flex NX Kit

Comparison of Flex NX and StructureScan Mini XT

If you have experience with other GSSI products, you might wonder what new features Flex NX brings to the table. The Flex NX retains many popular features of GSSI’s previous generations of concrete scanners, while incorporating new technology and a completely redesigned user experience. Below is an overview of notable similarities and differences.

Operation	Mini XT	Flex NX
Locates metallic and non-metallic objects in concrete	X	X
High frequency, high resolution performance	X	X
2D scanning and data imaging	X	X
USB port	X	X
GSSI Fusion® compatible	X	X
Safety wrist strap	X	X
Quick start guide	X	X
Rugged transit case	X	X
Powered by Nexus™		X
Adjustable handle		X
Remote display		X
Wireless project transfer		X
One-pass cross polarization data collection		X
Tap-to-Connect accessories		X
Flex Vision Positioning System		X
Warranty	2 years	2 years
Subscription required	No	No
Configuration Options		
Standalone or in a kit	X	X
Wired accessory antennas	Palm XT	
Wireless accessory antennas		NX25
Extension pole	X	X
LineTrac®	X	

Flex NX is designed to be more customizable, mobile, and convenient than our previous concrete scanners due to software and hardware improvements. Flex NX is what you’ve come to expect from GSSI – a cutting-edge product that is Simple, Flexible, and Trusted. Flex NX is built on GSSI’s newly completed Nexus platform, and the first in a series of industry-defining and transformative GPR systems.

What is NEXUS™?

NEXUS is GSSI's newest and most advanced technology platform, and it is the engine that will drive our future industry-defining innovations. A technological triumph, the core elements of Nexus will facilitate a profound leap forward in GPR performance, data stream integration, and user experience. Nexus is the tangible representation of GSSI's Simple, Flexible, and Trusted mission, and its continual evolution will lead to vast improvements in system design, application relevancy, and interoperability of Nexus-cored technologies. We invite you to learn more about Nexus, and its capabilities, by contacting your GSSI sales representative.

Flex NX and GSSI Fusion™

Flex NX was designed with GSSI's Fusion platform at the forefront. Our vision was to create a reporting platform that seamlessly integrated with our field devices. Fusion is the culmination of that effort. As a quick and easy reporting tool, Fusion acts as an efficient organizational system for uploading Flex NX data, adding results and descriptions, integrating field photos, and submitting a professional report branded with your company logo.

GSSI's mission is to make your scanning life as painless as possible. Our ultimate goal is the seamless interoperability of our hardware and software designs. We understand that, in most cases, a report is a procedural bottleneck that must be submitted before you leave the jobsite. To this end, Flex NX's project structure mirrors GSSI Fusion's project management environment. Create new projects on Flex NX, create Areas of Interest and capture results and then transfer your project to a mobile device or USB drive. Next, simply upload your projects to Fusion and your project will be set up just like you left it. Enter notes, add field photos, and generate a report. Then move on to your next job knowing that your polished and branded report will be digitally available to your client.

We invite you to learn more about GSSI Fusion, and how it can streamline your project reports, by contacting your GSSI sales representative.

GPR Theory Overview

Ground Penetrating Radar (GPR) is a geophysical method that uses radar waves to image subsurface materials. It is commonly employed in construction, geology, archaeology, civil engineering, and environmental studies. Nearly all GPR applications share a common goal: rapid and non-destructive assessment of subsurface targets for mapping, avoidance, or physical inspection. All GPR technology acts as a true remote sensing method, whereby imaging occurs before buried targets are visually inspected. In other words, we cannot know precisely what we are imaging until it is directly observed. However, experience with GPR will improve your interpretation of the resulting data, and knowledge of concrete construction techniques will provide greater insight.

GPR operates on the principles of electromagnetic wave travel and reflection. Basic GPR theory involves an antenna transmitting short waves of electromagnetic energy into the ground, concrete, or other material. The waves travel through different subsurface materials, partially

reflecting at boundaries with contrasting physical and chemical properties. The remaining waves travel deeper, reflecting from other boundaries until the waves dissipate. A receiving antenna records the reflections and plots them for display and analysis. The majority of modern commercial GPR systems use antennas containing both transmitter and receiver.

The depth penetration and resolution of GPR depend on several factors, including the frequency of the radar waves and the electromagnetic properties of a solid medium. Higher-frequency waves provide better resolution but have reduced penetration depth, while lower-frequency waves have greater penetration depth but lower resolution. Materials with high electrical resistance allow deeper penetration, such as air, concrete, and dry sand. Materials with high electrical conductivity, such as wet concrete and wet clay, dissipate the radar waves and vastly reduce penetration depth.

GPR measures the time elapsed between transmission and the return of reflections. The depth of targets or layers is based on the travel time and the speed of the radar waves. As an example, consider airplane detection using ground-based radar. The radar operator must determine the distance to an incoming airplane. To do this, they must use a distance, speed, and time calculation. To solve the problem, only two of the three variables are needed. The radar system records the time elapsed between the transmitted and received signals. Radar waves travel at a constant speed in air. The operator can then determine the distance using the time and speed values. A GPR system works in a similar fashion, though the depth calculation is a bit more complicated. The GPR system precisely records transmit and receive times, so we can easily constrain the time variable. In most cases, the depth of targets is unknown. We must therefore determine the speed of the radar waves to solve for depth. Here's the tricky part: GPR waves travel at different speeds depending on the material they pass through.

To calculate a precise target depth we must determine the speed of the radar waves using a dielectric constant value. Multiple methods are available, and in order of least to greatest accuracy these include tables of dielectric values for different materials, hyperbola matching using software, or setting a precise target depth from physical measurements. In most cases, hyperbola matching is the method of choice; picking a number from a table just isn't accurate, and knowing the true depth of a target is not common. Once the dielectric constant is determined, the system calibrates the depth scale accordingly.

The Anatomy of a GPR Profile

GPR data are presented as vertical profiles, much like observing the side of a saw cut, displaying depth below surface and distance traveled. As discussed above, the depth scale is only as accurate as the current dielectric value. On the other hand, the distance scale is very precise because it is measured with integrated distance encoders. This distance precision ensures accurate markouts, whether collecting data in forward movement or using backup cursors when traveling in reverse.

As reflections return to the receiving antenna they are plotted against travel time and assigned a range of colors based on their phase/polarity and amplitude. The result is a single scan that is represented by the O-Scope. Additional scans are collected as Flex NX moves forward, resulting in a continuous GPR profile. All GPR profiles exhibit a series of flat, high amplitude bands that appear at and around the ground surface. These reflections are the direct wave, and they are created when GPR energy travels from transmitter to receiver before it leaves the antenna. The center of the first positive (white) band is the position of the ground surface.

A typical GPR profile contains two categories of reflections: targets and layers. Targets are expressed as hyperbolas representing discrete objects, such as rebar and conduit. These hyperbolas can vary in amplitude based on the material of the object. Metallic objects produce high amplitudes, while air-filled PVC and other synthetic materials generate weaker hyperbolas.

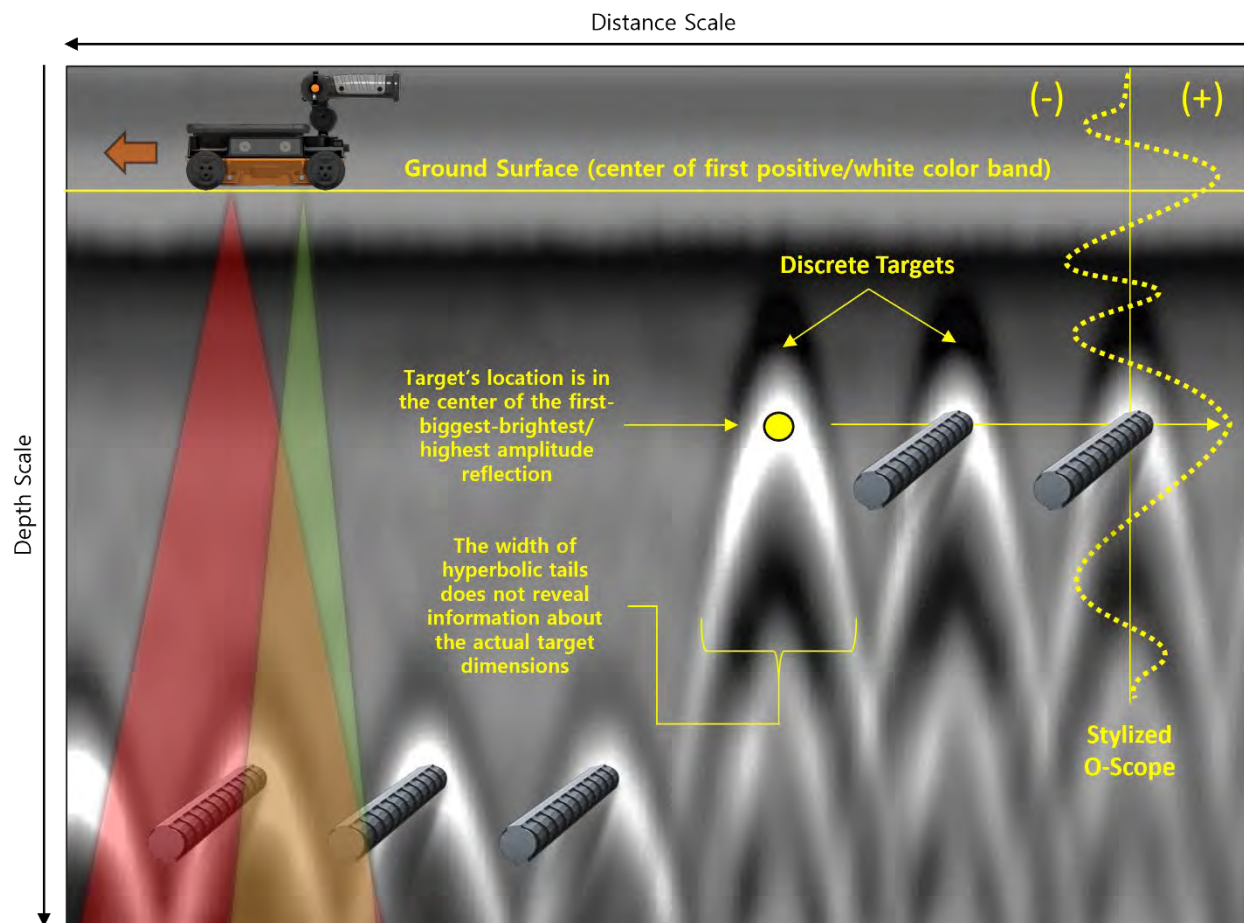

Target hyperbolas will widen with increased depth, and to the untrained eye these deeper targets could be mistaken for larger objects. However, the true diameter of a target cannot be derived from the shape of a hyperbola. Layers are continuous boundaries, like the base of a slab or an air void under the slab, that can be tracked along a profile. Like targets, layers can vary in phase and amplitude but their reflection characteristics are based on the nature of the overlying and underlying materials.

To an experienced GPR operator, the phase and amplitude of targets and layers reveals additional information to enhance data interpretation. Enabling the O-Scope display will assist with advanced interpretations. GPR energy cannot penetrate metallic targets, so a large amount of energy is reflected back to the antenna and registers as a high amplitude target. This is convenient for locating metal reinforcement and conduit, but solid metal structures like pan decking are impenetrable to GPR energy. Any features of interest on the other side of pan decking, or thick layers of metal reinforcement, will not be resolvable. Nor can GPR image the contents of metal pipes. Additionally, metal objects display a white-black-white pattern of stacked reflections. This pattern, along with high amplitudes, typifies metal targets and demonstrates that the energy decreased in speed as it passed from concrete to the metal.

In other cases, the pattern of reflections will be reversed (black-white-black). This pattern suggests that the energy increased in speed at a material boundary, such as the air void in a PVC pipe or an air void within or beneath a concrete slab. These reflections will often exhibit lower amplitudes and could be masked by hyperbolas from reinforcement.

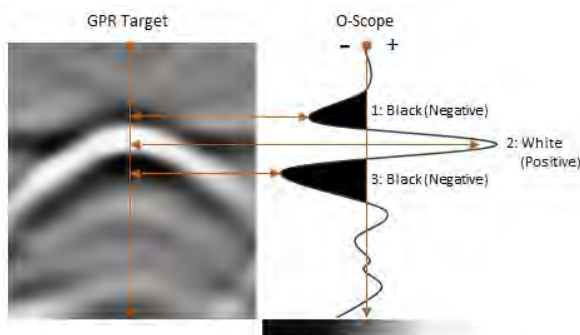

The first reflector is black (negative), but the **first-biggest-brightest reflector** is white (positive). This demonstrates that the GPR energy decelerated at the concrete/target contact. This target could be interpreted as metallic or possibly water-filled PVC.

Marking this and other targets on the slab surface would show the broader pattern, improving the interpretation.

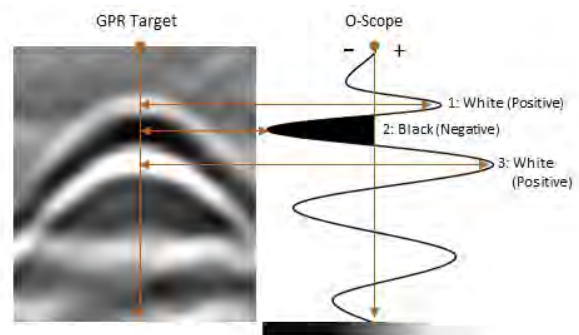

The first reflector is white (positive), but the **first-biggest-brightest reflector** is black (negative). This demonstrates that the GPR energy accelerated at the concrete/target contact. This target could be interpreted as air-filled PVC or potentially as a small air void.

Marking this and other targets on the slab surface would show the broader pattern, improving the interpretation.

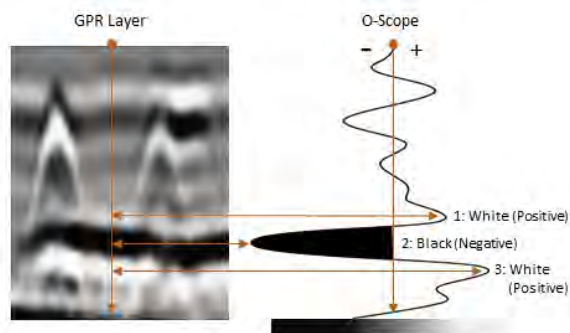

The first reflector is white (positive), but the **first-biggest-brightest reflector** is black (negative). This demonstrates that the GPR energy accelerated at the concrete/layer contact. This target could be interpreted as an air-filled void at the base of the slab.

Marking the extents of this layer on the slab surface would show areas of voiding, allowing targeted remediation efforts.

Common GPR Uses in Concrete Scanning

GPR is a non-destructive method that provides insight into the condition, composition, and structural characteristics of concrete elements. This helps in ensuring the safety, durability, and efficient management of concrete structures. The non-destructive nature of the method makes it a rapid, safe, and cost-effective means of identifying slab contents and potential hazards.

Concrete scanners typically use GPR to investigate concrete prior to saw cutting or core drilling. At predetermined cutting locations the operator marks out reinforcement, conduit, and structural elements such as beams, cables, and pan decking. This allows the cutting and coring crew to avoid damaging important elements in the slab.

GPR is also used for non-destructive testing (NDT) and structural forensics to assess the construction and health of existing concrete structures. In this application, inspectors employ GPR to ensure the reinforcement in the slab and slab thickness match the planned specifications. Commonly measured factors include rebar spacing, rebar depth in the slab, and the presence of post-tensioned cables and other forms of reinforcement. These measurements are also carried out when renovating older buildings, helping to verify that the concrete slabs are strong enough to support the planned loading.

In some cases, voids form under concrete slabs due to erosion or soil compaction. Subgrade materials can be removed by water below the slab, and compaction occurs from soil settling or loading from above. In either case, the resulting void space poses a major risk to the integrity of the structure. GPR is sensitive to the transition from concrete to air and can determine the areal extent of void spaces. The slab can then be remediated, usually by injecting polyurethane foam through numerous tiny holes drilled in the concrete. GPR can help ensure that the holes are drilled safely, too.

Flex NX Hardware Overview

Handle Configurations

The Flex NX handle is ergonomically designed to promote ease of use and maximum flexibility. The handle is highly configurable, with a wide range of adjustment angles and built-in safeguards to prevent screen damage. To adjust the handle, simply loosen the knob, reorient the handle, and tighten. To remove the handle, fully loosen the knob. Use the attached RAM Mount ball to connect an extension pole or a custom RAM solution.

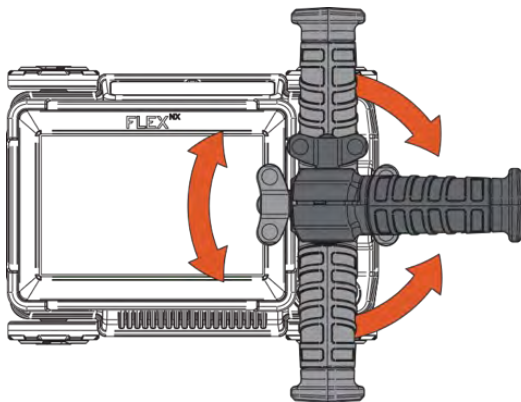



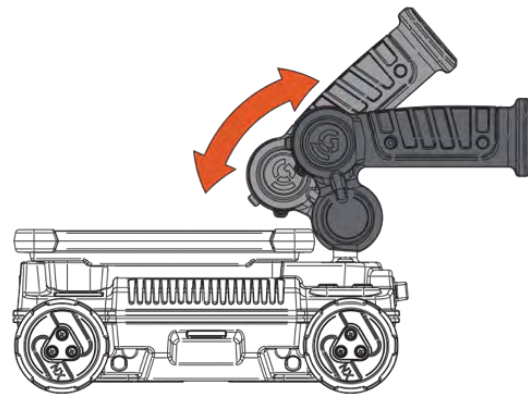

Full range of horizontal rotation



Vertical movement limited to prevent display damage

Touchscreen Display Care and Maintenance

Integrated into Flex NX is a large (7.0-inch diagonal) multi-touch display. The display is not removable and should damage occur the entire Flex NX system should be returned to an authorized repair facility. To ensure proper care and maintenance of the Flex NX touchscreen display, consider the following:

-  Clean the screen regularly. Use a soft, lint-free cloth to gently wipe the screen surface. Avoid using abrasive materials, paper towels, or rough fabrics that may scratch the screen. If necessary, lightly dampen the cloth with water or a screen-cleaning solution.
-  Turn off the display before cleaning. This allows for better visibility of smudges and reduces the risk of accidental actions on the screen.
-  Avoid harsh chemicals. Harsh chemicals, solvents, or ammonia-based cleaners can damage the screen's protective coating. Use only mild screen-cleaning products.
-  Apply gentle and controlled pressure when interacting with the touchscreen. Excessive force or tapping can lead to cracks or damage.

Battery Usage

The Flex NX system and NX25 satellite antenna (sold separately) each include two Lithium-ion batteries.

Note: the batteries are not compatible between Flex NX and NX25, but both battery styles use the same charging station.

Flex NX Battery

To insert the battery, slide the battery door latch to the left and open the door. Insert the battery with the battery contacts facing upward and towards the Flex NX system. Ensure that the battery latch is fully engaged when closed.

To eject the battery, simply slide the latch to the left and open the door. An internal spring will partially eject the battery, and the battery can then be removed by hand.

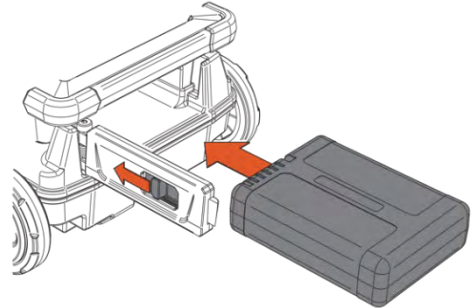

NX25 Battery

To insert the battery, orient the battery contacts downward. Next, slide the battery latch lock forward and use the battery to push up on the battery latch. The battery latch will snap into place once the battery is fully inserted.

To eject the battery, use your index finger to slide the battery latch lock, then insert your thumb into the front access window and push the battery out of the latch.

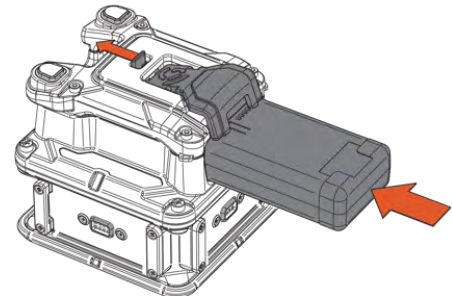

Powering On Flex NX and NX25 Satellite Antenna



Insert a fully charged battery, then press and hold the two power buttons to power on Flex NX and NX25. Use this process to power down these devices; GSSI does not recommend ejecting the battery to power down.

Pairing Satellite Antennas

Flex NX uses near-field communication (NFC) to pair with satellite antennas.

Pairing a satellite antenna to Flex NX is simple. First, power on Flex NX and wait for the Main Dashboard to appear. Next, power on NX25 and observe the red indicator light. Wait for the red indicator light to flash blue, indicating that NX25 is ready to pair. Bring NX25 close to Flex NX and make contact between the two NFC labels. The indicator light will transition to solid blue, then to flashing green, and finally solid green when the two units are paired. For future scanning sessions simply power on Flex NX, then power on NX25 and wait for the indicator light to turn solid green.

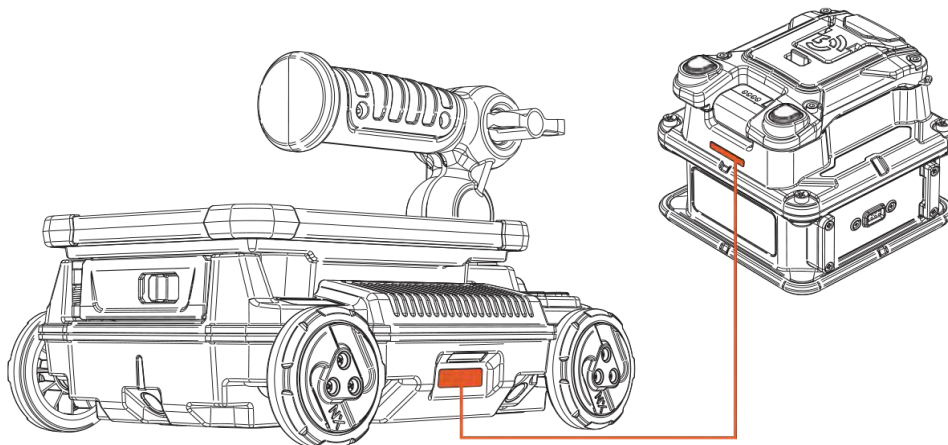

Flex NX displays NX25 data and provides complete access to NX25 configuration options and collect mode functions. Use your satellite antenna to collect data while viewing the results on Flex NX's screen. Alternatively, connect a Wi-Fi enabled smartphone, tablet, or computer to mirror the data collection screen. See the Connecting an External Viewing Device section (page 29) for more information on screen mirroring.

Holding NX25

The NX25 satellite antenna connects to Flex NX via Wi-Fi, and GSSI highly recommends observing safe Wi-Fi exposure habits when using this antenna. Please consult the following images, and grip NX25 according to our recommendations.

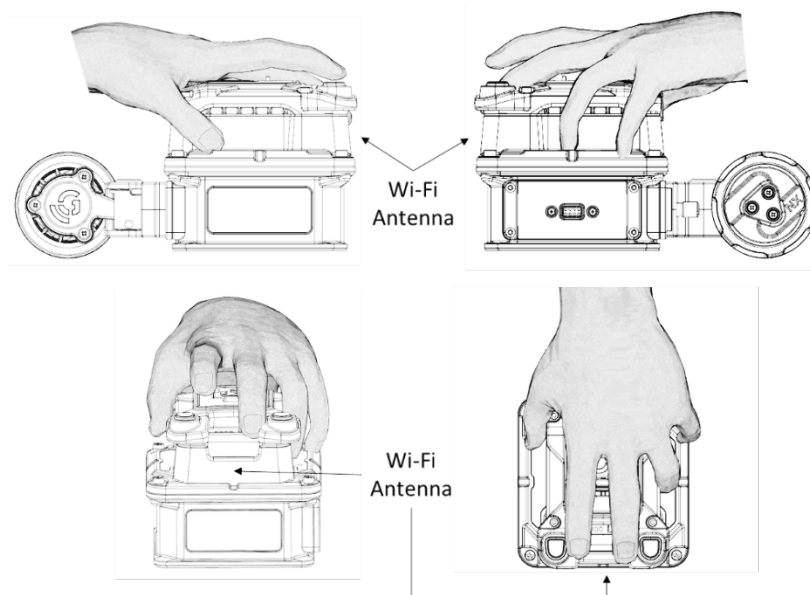

Using Two GPR Antennas: Standard and Cross-Polarized

Flex NX contains two separate antennas with their transmitter-receiver pairs in different orientations. The front antenna, with **red** lasers, is in the standard orientation for commercial GPR systems. The rear antenna, with **green** lasers, is cross-polarized. The side lasers mark the center of each antenna, as do the front and rear lasers.

When displaying both data channels in Stacked Mode the standard antenna (Channel 1) is the top profile and the cross-polarized antenna (Channel 2) is the bottom profile. You'll notice that the two channels do not align horizontally, nor do the two backup cursors, yet targets in both channels are aligned. Channel 2 is shifted to the right relative to Channel 1. The offset corrects for the physical distance between the antennas, as Channel 2 does not display data until it has passed the starting point of Channel 1.

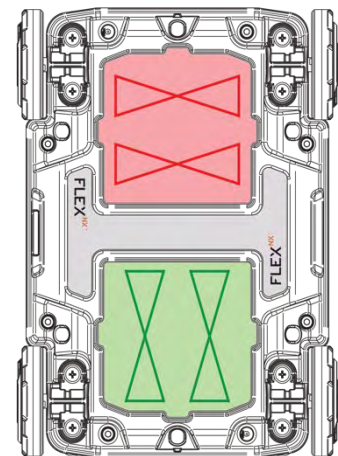

The two Flex NX antennas are designed to work in tandem, providing an exceptional scanning experience employing one-pass cross-polarization. Both antennas have specific strengths. The standard antenna is aligned perpendicular to the path of travel, as is common for most commercial GPR systems. In this orientation it is optimized for imaging metallic targets that run perpendicular to the direction of travel. This means that rebar, metal conduit, and other metal targets will stand out, appearing as high amplitude (bright) hyperbolas with expansive tails.

The standard antenna orientation is the scanning workhorse, but some targets will be difficult to image due to the nature of concrete installations. This includes PVC and other synthetic materials that are 'overshadowed' by the amplitude of metallic targets. Additionally, the expansive

hyperbolas from wire mesh, dense rebar, and other reinforcement often overlay and obscure deeper targets.

The cross-polarized antenna is not as sensitive to metallic targets, though they will still appear in the data. The main advantage is the reduction of amplitudes from metal targets and the downplaying, or sometimes altogether removal, of hyperbolas that obscure deeper targets. This leads to a more refined view of deeper slab elements, including the slab/grade contact where air voids may be present.

By utilizing data from both standard and cross-polarized antennas Flex NX can better discriminate between different types of objects or materials and improve overall data resolution and accuracy. GSSI recommends scanning with both antennas active so you can view a complete picture of the slab contents.

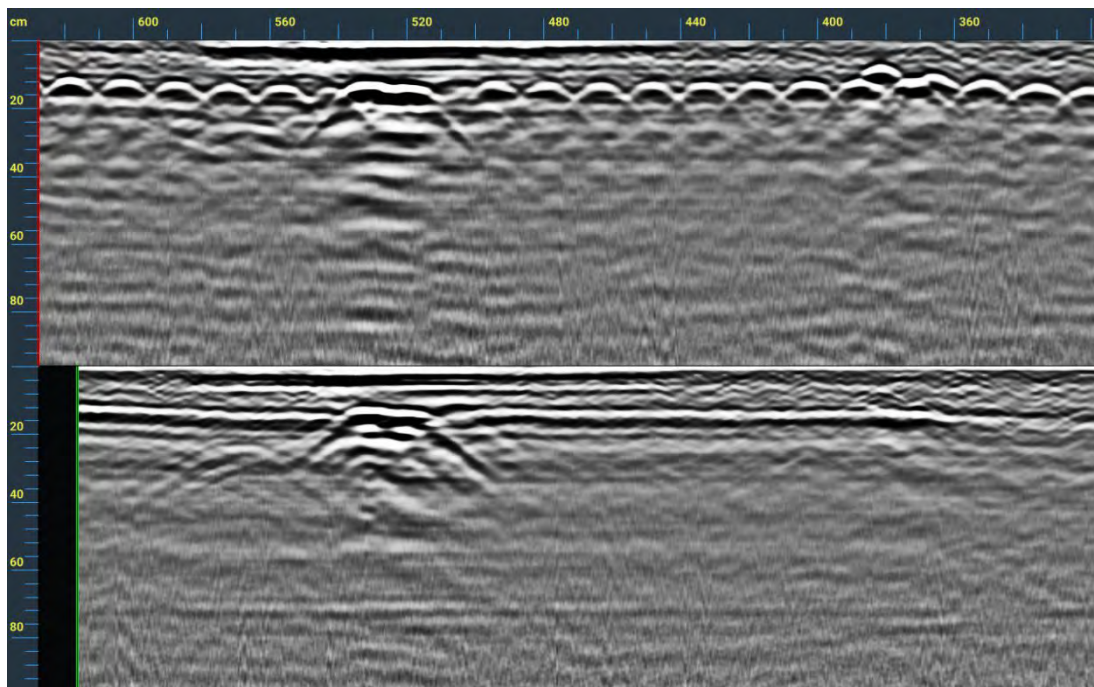
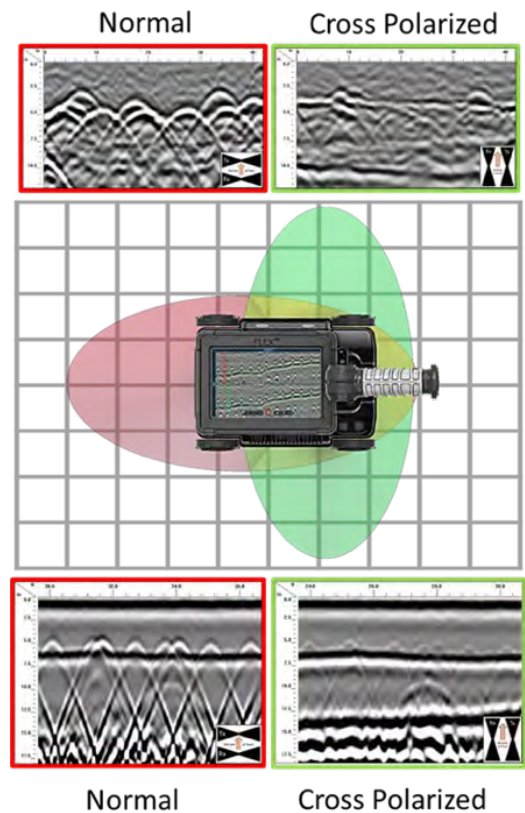

The top profile (standard orientation) shows shallow wire mesh and a possible conduit bank. In the bottom profile (cross-polarized) the wire mesh is not visible, and the removal of hyperbolic tails reveals more details about the conduit bank and a previously obscured target to its left.

Flex NX User Interface

This section will familiarize new users with the Flex NX user interface. By the end of this section, you will be able to navigate through the system, create and manage projects, and be ready to collect data.

Main Dashboard

The Main Dashboard is the control center for Flex NX. From here, you can:

- Start a New Scan
- Access Projects
- Access System Settings
- Wirelessly connect to your personal device
- Access Technical Support
- Connect and configure NX accessory antennas





The Main Dashboard is separated into three panes: Top Navigation, System and Support, and Recent Projects. Keep reading for a detailed description of these panes and their features.

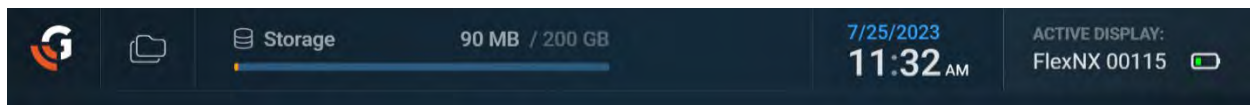

The Dashboard Top Navigation menu provides access to the Projects Portal, system storage information, date and time, and the currently active device. See below for a more detailed functionality overview.



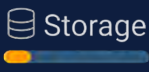



Main Dashboard: Top Navigation Menu

	<p>Return to Main Dashboard. Tap this icon to return to the Main Dashboard. This icon is also available on the Data Collection, Projects Portal, and Project Profile screens.</p>
	<p>Projects Portal Icon/Access Project Portal. Tap the Projects Portal icon to access all project folders on your Flex NX. Click an individual project folder to access its Project Profile and view associated Results and Data.</p>
	<p>Current (orange) and Total (blue) Storage Bar. You can transfer Results and Data from your Projects to GSSI Fusion or your computer, or delete existing project folders, to free up additional storage space.</p>
<p>313 MB / 200 GB</p>	<p>Current / Total Storage. Flex NX has a total storage capacity of 200 GB.</p>
	<p>Battery Life Indicator. Displays the charge state of the currently active device. This will usually refer to the Flex NX battery, though it will show the NX25 battery if it is the active device.</p>
<p>5/31/23 10:45 AM</p>	<p>System Date and Time. Set the current date and time for an accurate timestamp. The time and date will determine file naming.</p>
<p>ACTIVE DISPLAY: FLEX NX</p>	<p>Name of Active Device. If an NX accessory antenna is connected and activated, that antenna will be displayed as the active device. Switch between Flex NX and other antennas using the carousel on the Main Dashboard's System and Support pane.</p>
	<p>Battery Status for Active Device. This icon displays the battery status for the device currently active. Activating a satellite antenna, such as the NX25, will display its battery status.</p>

The Main Dashboard System and Support pane features the device carousel, device serial number, current software version, and the System Settings icon. It also includes the Wireless Connect and Technical Support icons. See below for a detailed description of functionality.



Main Dashboard: System and Support Pane



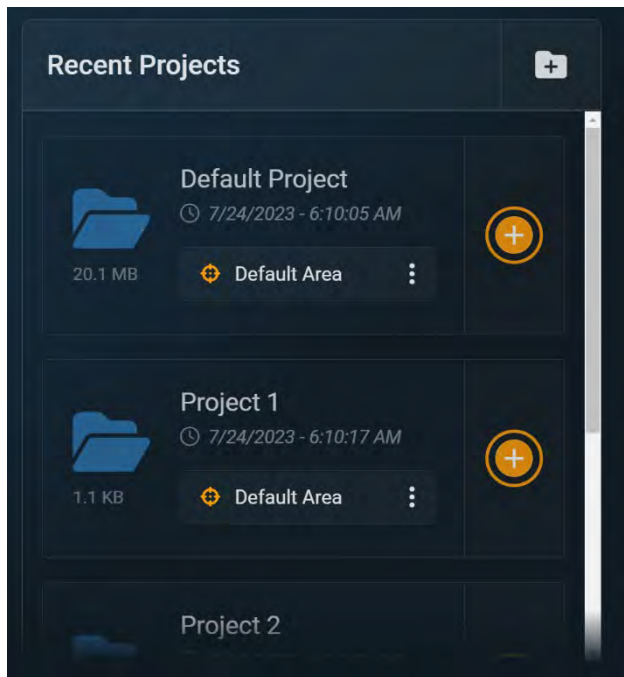

	<p>Battery Life Indicator. A fully charged Flex NX battery can provide up to 3.5 hours of use. An NX25 battery delivers up to 6 hours of use.</p>
	<p>System Settings. Tap this icon to access the System Settings and Health Settings screens.</p>
	<p>Technical Support Portal. Tap this icon to display GSSI's Technical Support phone number and business hours, as well as a QR code linked to helpful resources.</p>
	<p>Wireless Connect. Tap this icon to wirelessly connect a personal device, then mirror your collection screen using a web browser. Proceeding screens will walk you through the connection and display process.</p>
	<p>Carousel Menu. Swipe left or right to select a device, then tap a device image or the System Settings icon to view System Settings or Health Settings information. Connected accessory antennas also appear in the carousel.</p>
<p>Software Version 1.90</p>	<p>Software Version. Displays the currently installed software version. Tap this icon to quickly proceed to the Software Update screen.</p>



The Recent Projects pane displays a list of your most recently accessed project folders. When first used, your Flex NX will only have a Default Project folder. As you add more projects they will appear in this pane, ordered by most recent use. If many projects are listed, view previous projects by scrolling through the list or by accessing the Projects Portal.

The main function of the Recent Projects pane is to quickly select a working folder and begin scanning. There are other useful features here, and they are outlined below.

Main Dashboard: Recent Projects Pane

	<p>Create New Project. Tap this icon to create a new project. You can then save data and results to different areas of interest within the project.</p>
	<p>Start New 2D Scan. Tap this icon to start a 2D scan in the selected Project, and within the currently active Area of Interest.</p>
	<p>Current Area of Interest/Switch Area of Interest. Change Areas of Interest to save data and results to a specific location within your work site or project.</p>
	<p>Project folder. Tap to access, view, and manage saved Results and Data. The total project size is also displayed.</p>
<p>Default Project 7/24/2023 - 3:45:37 AM</p>	<p>Project Name. This icon displays the Project Name and the last date and time the project was updated.</p>

System Settings

Tap the gear icon on the Main Dashboard to navigate to the System Settings screen. Use System Settings to customize your Flex NX or NX accessory antenna preferences. This portal is the Flex NX command center for enabling or disabling Wi-Fi, lasers, and the Save Prompt. You can also modify system time and date, change the measurement units and language settings, adjust system volume and screen brightness, and assign quick actions to programmable buttons.

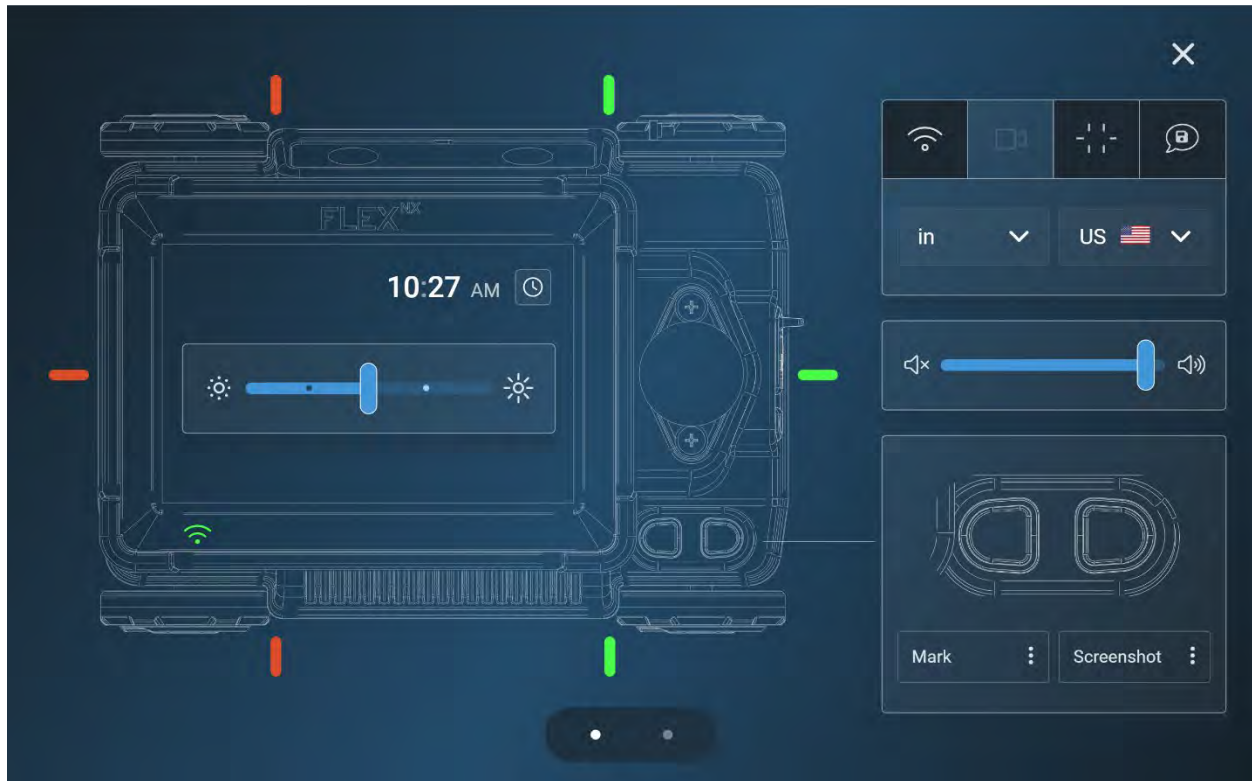

System Settings Controls

	<p>Date/Time. Tap the clock icon to set the current date and time of day. This will directly affect scan data file numbering.</p>
	<p>Screen Brightness. Adjust screen brightness to reduce battery consumption or to improve screen visibility.</p>
	<p>System Settings. Customize settings to toggle Wi-Fi connections, the Flex Positioning System, side and front lasers, and the Save Prompt. Enabling Save Prompt will generate a save or delete popup in Collection Mode when closing the current scan. The Flex NX graphic highlights enabled features.</p>

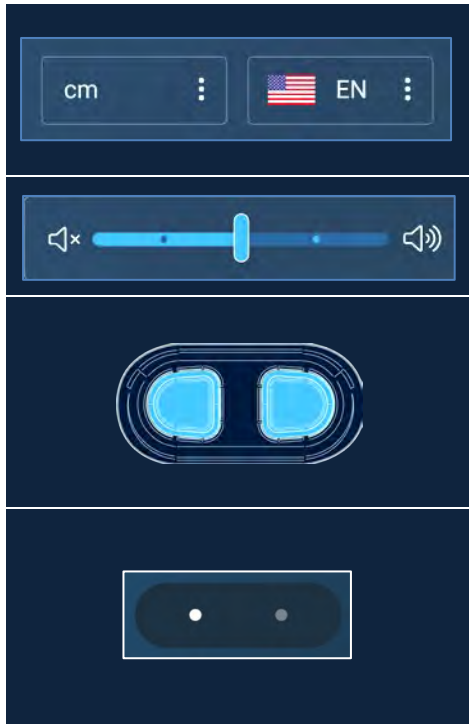

Units of Measurement/Language. Adjust units of measurement (cm, in) and select the display language (English, Spanish, Japanese, Korean, Chinese, and French).

Volume Adjustment. Adjust the volume to increase, decrease, or silence the system’s audio cues.

Button Functions. Flex NX and NX accessory antennas each have two user programmable buttons. Available functions include Mark, Start New Scan, Delete and Screen Grab. Additional functions may be added with future software updates. Functions can be set to either button.

System Settings/System Health Toggle. Located at the base of the System Settings and System Health screens. Switch between System Settings (left dot) and System Health (right dot) for Flex NX and NX satellite antennas (if paired and activated).

Date and Time Settings

Update the Time and Date settings using the provided calendar and digital clock display. Flex NX incorporates the day/month/year into its file naming, and thus an accurate date will lead to easier file management and record keeping.

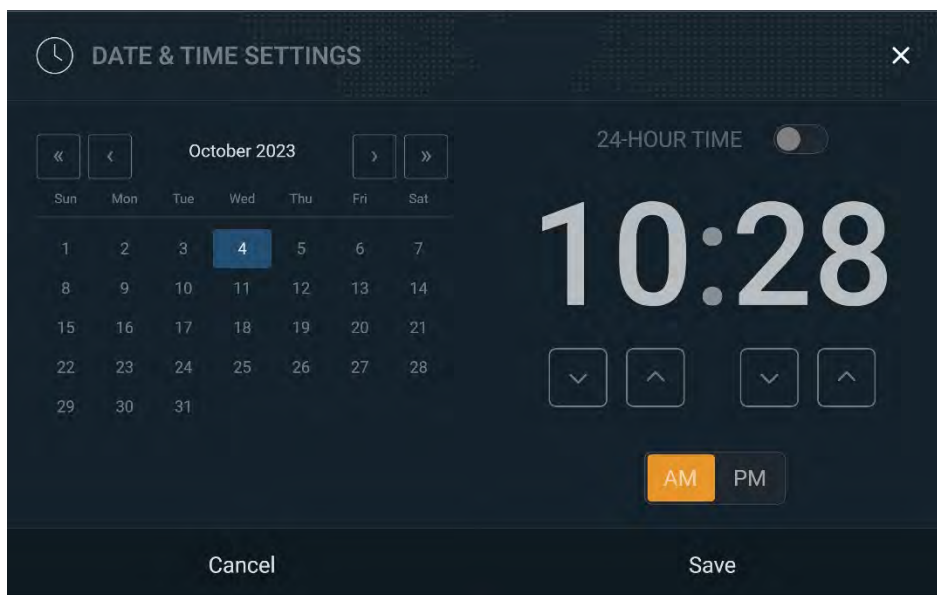

NX 25 System Settings

Connecting an NX25 provides access to its own System Settings screen.

At the Main Dashboard, swipe your finger left or right on the Carousel Menu to change between Flex NX and NX25.

Tap the NX25 icon to advance to the NX25 System Settings screen or tap the gear icon next to the battery indicator.

Use the System Settings screen to customize the programmable buttons. The available options include Mark, Start New Scan, Delete and Screen Grab. Additional functions may be added in future software updates.

Tap Disconnect NX25 to end the pairing session. Tap Software Update NX25 to update the software; this procedure requires updating Flex NX first. For more details, see the Updating Flex NX and NX25 Software section below.

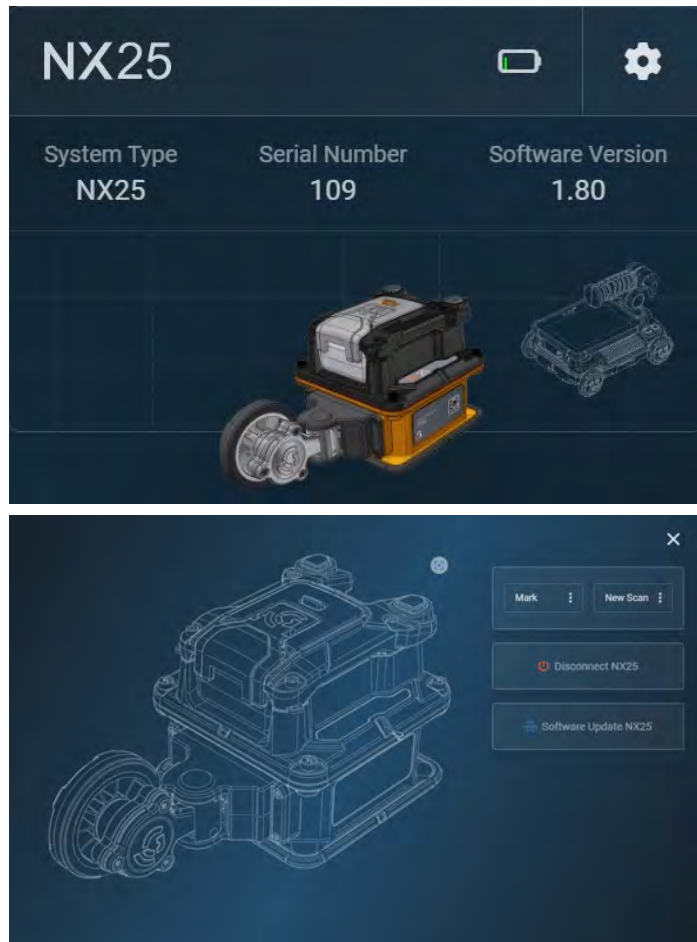

Health Settings

The Health Settings portal is the second screen in System Settings. Access Health Settings by tapping the second dot at the base of the screen. This portal includes icons for updating software and downloading system log files. Log files are intended for GSSI technical support use and can be downloaded to a USB drive and emailed to the GSSI team when requested.

Health Settings: Software Update

We will periodically release software updates for Flex NX and NX satellite antennas. Future updates will fix bugs and other software issues and could implement new user features. GSSI recommends regular visits to the Flex NX support page ([Flex NX Support Page](#)) to check for new software releases. You can also scan the QR code on the Flex NX/NX25 Quick Start Guide's cover or use the QR code provided by the Flex NX Software Update function.

To update Flex NX and NX accessory antennas, visit the [Flex NX Support Page](#) with your computer and download the latest update to a USB drive. Consult the following procedure to initiate and complete the update process.

Health Settings: Updating Flex NX

- 1** Power on Flex NX and make sure the battery is near full charge. The system will not begin the update process if the Flex NX battery is lower than 50% charged.
- 2** Insert the USB drive containing the installation package.
- 3** On Flex NX, navigate to the System Settings panel and then to the System Health screen. Tap Software Update to continue. Alternatively, to quickly access the Software Update screen you can tap Software Version on the Main Dashboard.

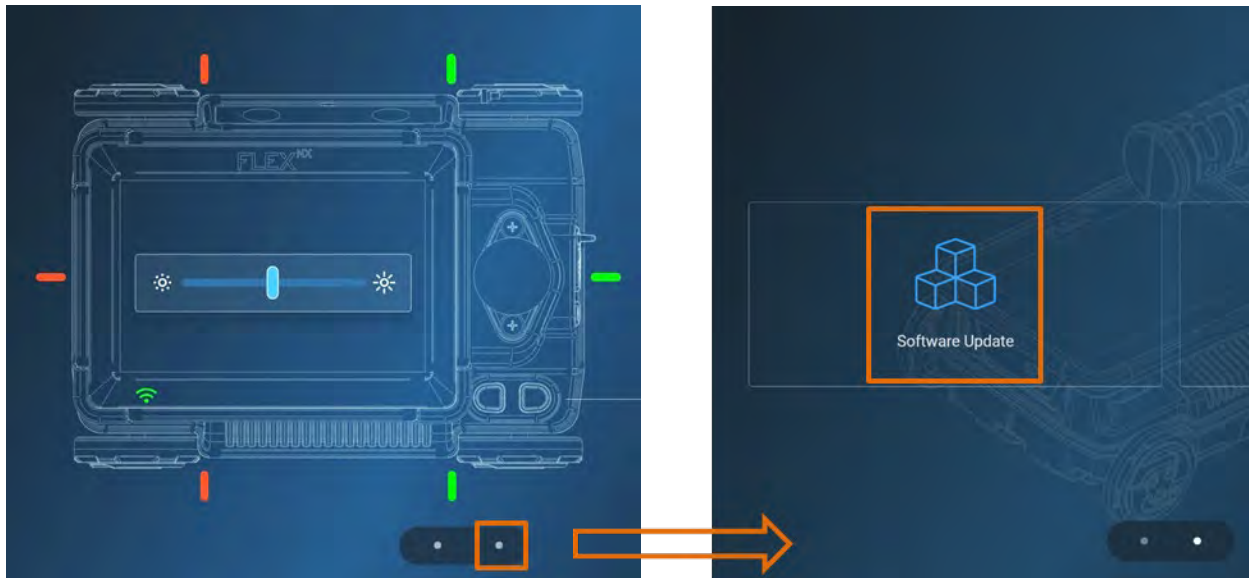

Flex NX will display a USB drive screen if a USB drive is not inserted or detected.

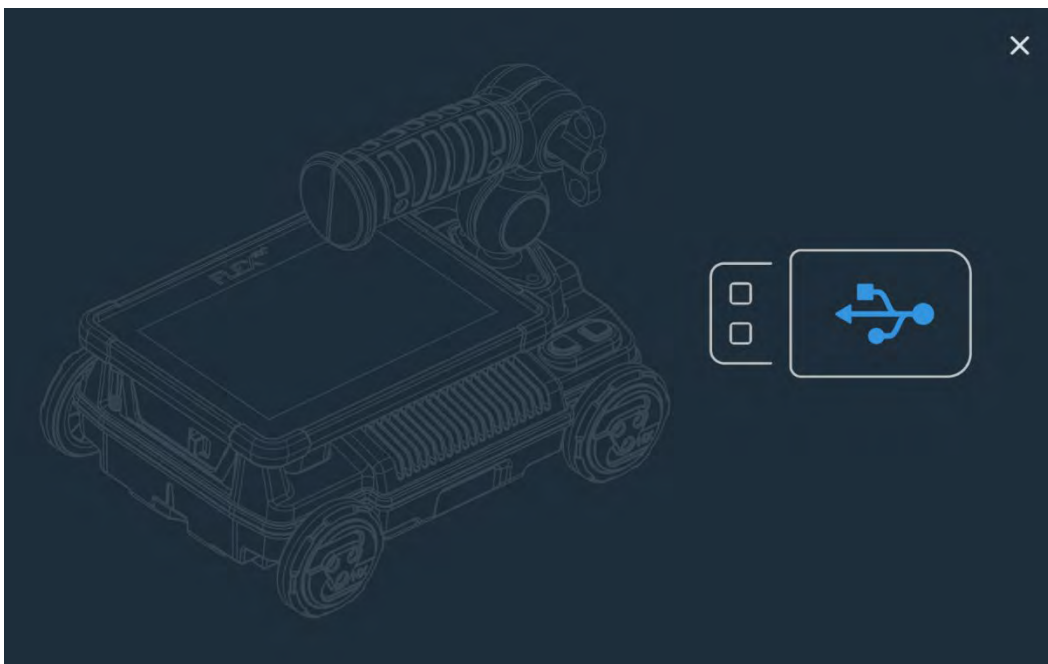

Flex NX will transfer the install package once a USB drive is detected.

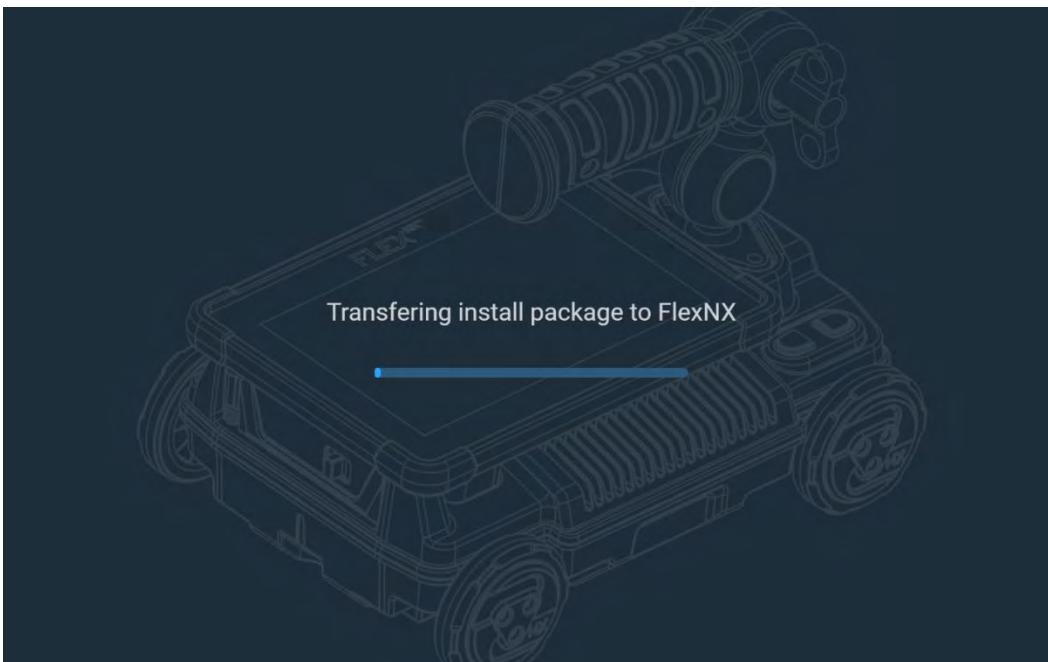

A new screen will appear once the transfer is complete. Tap Confirm Install. Feel free to remove the USB drive; it is no longer needed.



Flex NX will then install the software update and will reboot once the progress bar is full. Do not power off Flex NX during this process.



The system will reboot to a “Configuring Flex NX v...” screen. Do not power off Flex NX during this process.

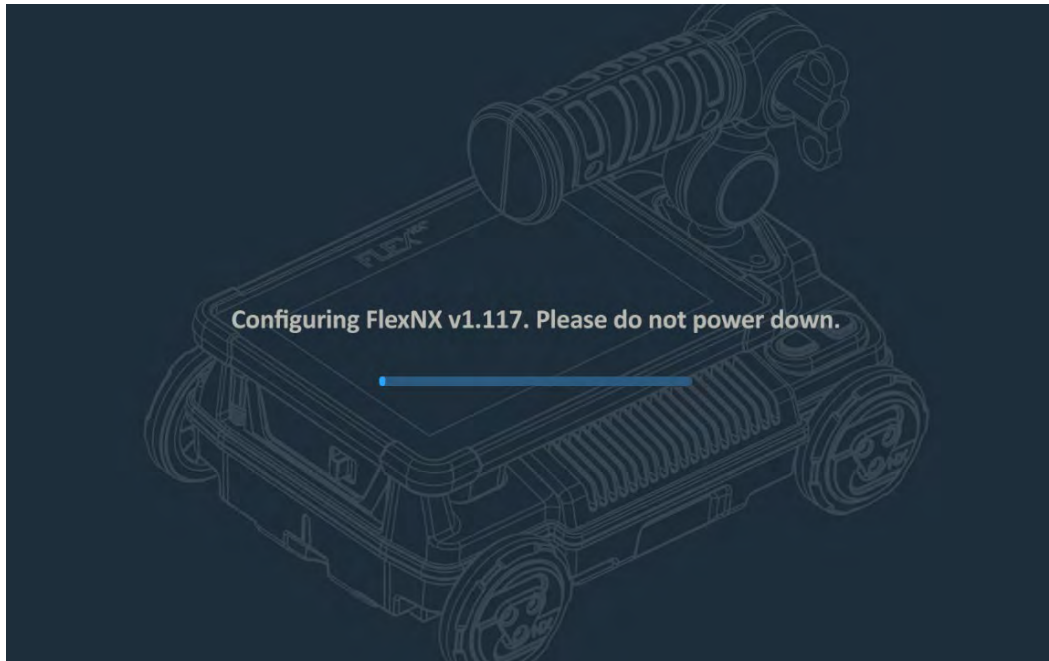

The system will reboot once more and then return to the Main Dashboard.

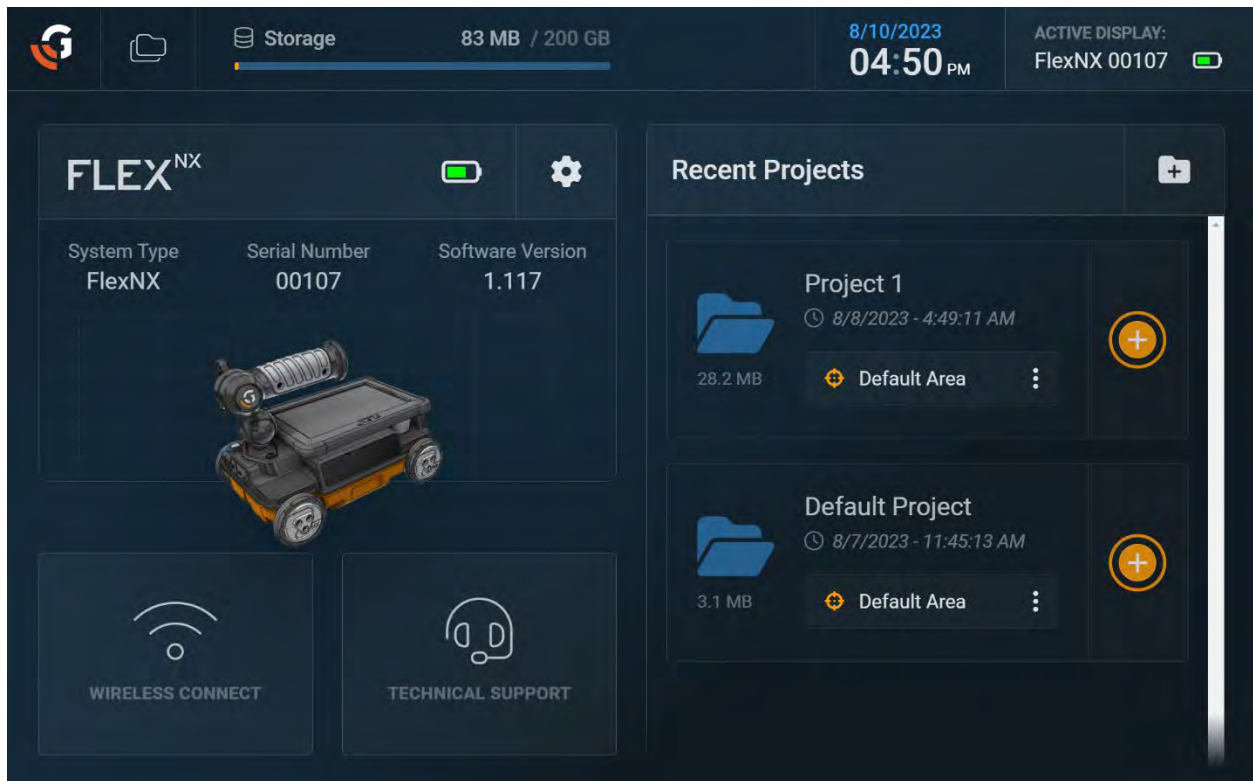

Health Settings: Updating NX25

The NX25 software update is controlled by Flex NX, therefore your Flex NX must be updated prior to NX25. Before continuing, confirm that your Flex NX has the latest software version.

Power on Flex NX and make sure the battery is near full charge.

Insert a fully charged battery into NX25 and power on.

- If your Flex NX and NX25 were previously paired, NX25 will connect to Flex NX. Wait for the NX25 indicator light to turn solid green.
- If your Flex NX and NX25 have never been paired, please refer to the Pairing Satellite Antennas section (Page 11) and pair NX25 before continuing with the update process.

Once connected, Flex NX will detect the current software version on NX25. Mismatched versions will automatically trigger the start of the NX25 update process.



Tap Confirm Install to continue with the update. Flex NX will power down if this window is closed using the X. Use the QR code to view release notes for the update.

After tapping Confirm Install, NX25 will display a purple blinking indicator light. Do not power down NX25 or remove the battery while the purple light is blinking.

The screen will transition to a “Copying install files...” page. NX25 will still display blinking purple.

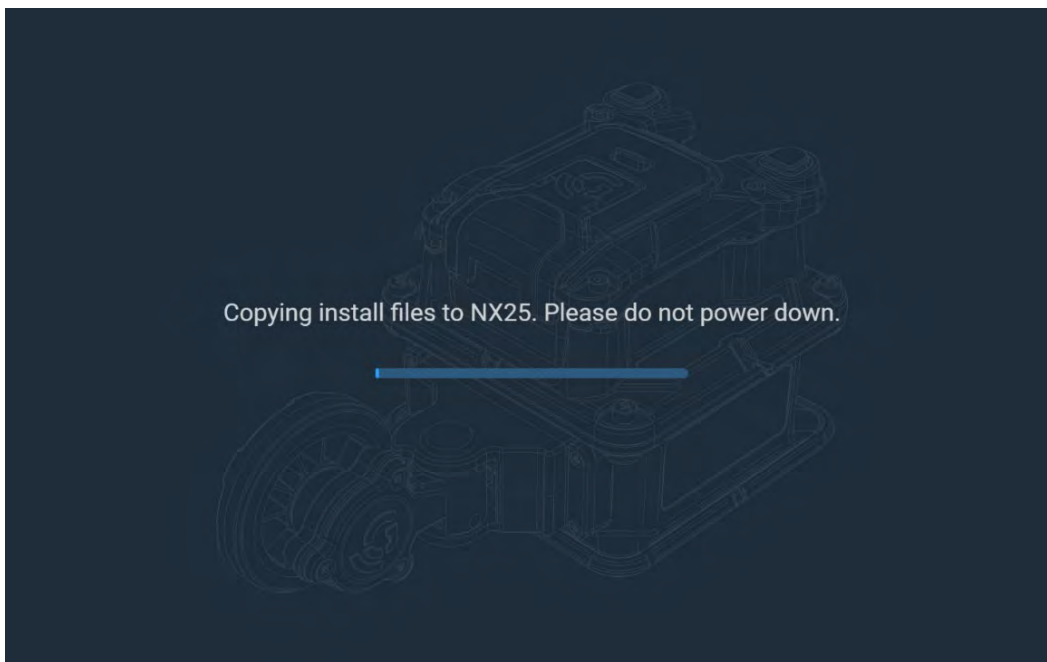

After install files are copied, Flex NX will show an “Installing...” page. NX25 will still display blinking purple.

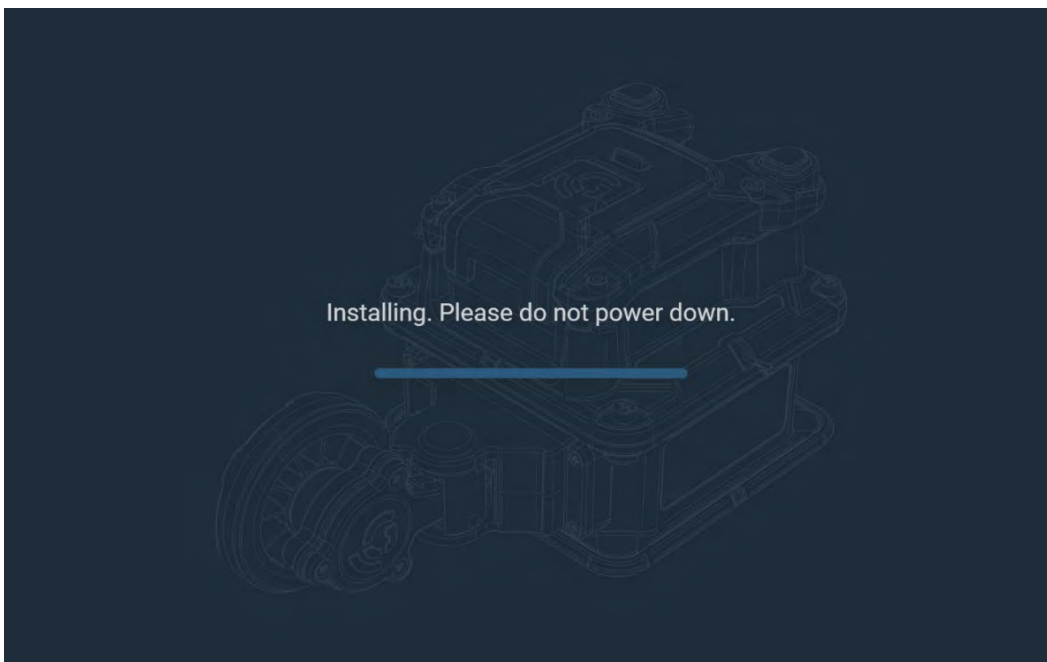

The next update screen shows an “installing system...” page. NX25 will still display blinking purple.

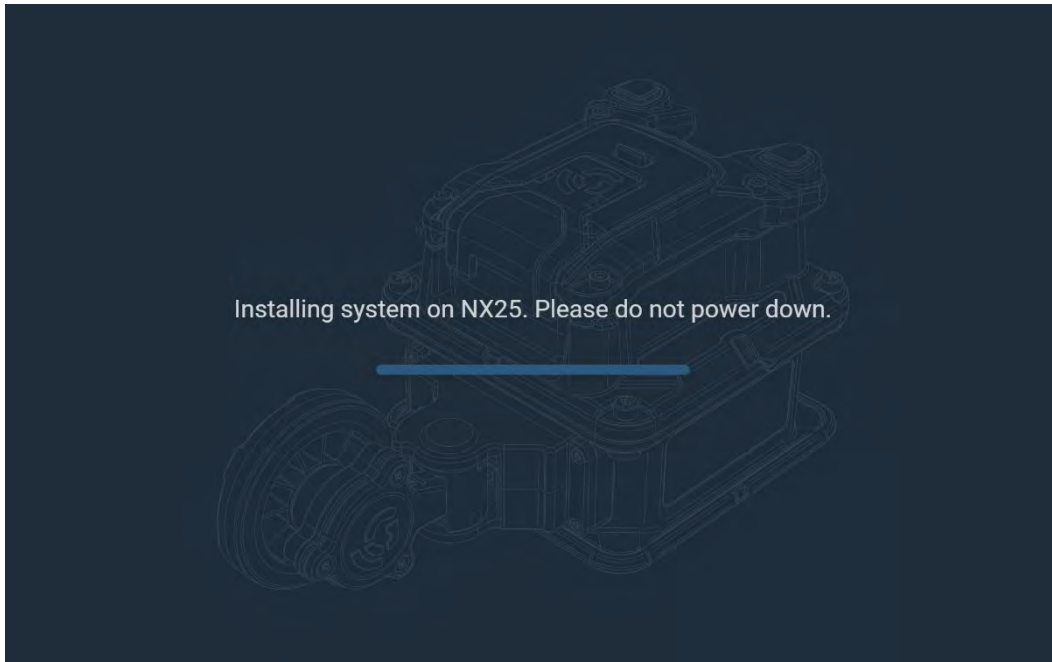

Flex NX will then display an “Installing NX25 vX.XX” page. Tap Dashboard to return to the Flex NX Main Dashboard. NX25 will continue to display a blinking purple indicator light.

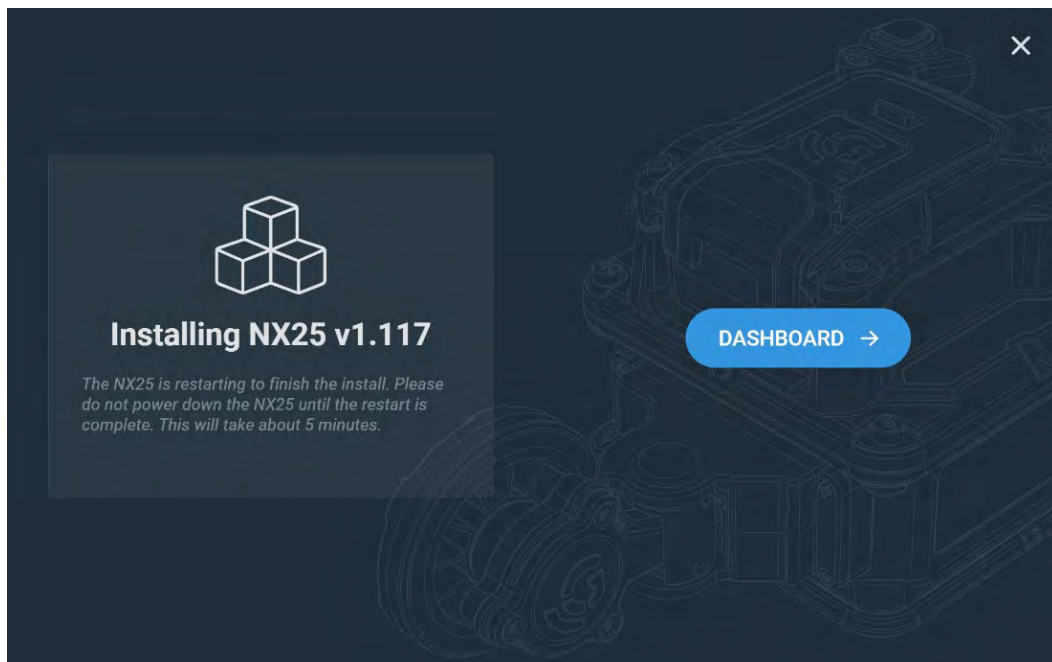

Monitor NX25 and wait for the indicator light to turn solid green. Do not power down NX25 or remove the NX25 battery until the indicator light is green.



The update is complete when NX25 appears as selectable on the Main Dashboard's carousel.



The NX25 indicator light flashes purple when updating. Do not power down NX25 or remove the battery until the indicator light is solid green.

Health Settings: Log File Download

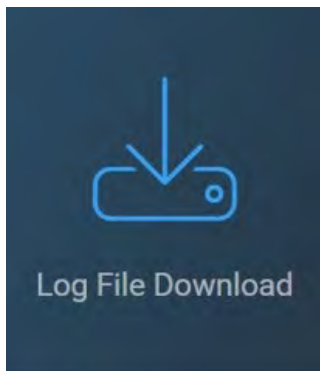

The Log File contains system-related data to assist the GSSI technical support team.

Tap Log File Download to create a .ZIP file and then transfer via USB or to a wireless device. Refer to the Transferring Data section to review the steps for downloading from Flex NX.

You can then email the file(s) to our Software Support Team if instructed to do so.

Connecting an External Viewing Device

Flex NX can cast its data collection screen to a personal device, such as a phone, tablet, or computer. You can then view your data on another device during data collection. Try pairing your Flex NX to a tablet for a larger viewing screen, or to a smart phone for a lighter and more portable display.

Step 1: Connect Mobile Device from the Main Dashboard



Tap the Wireless Connect icon.



If using a computer or a device without a QR Code scanning camera, select and connect to the Flex NX SSID from the wireless networks in your device's settings.

Step 2: Scan the QR code to connect to Flex NX's wireless network. Tap Next.



Step 3: Mirror Data Collection Screen

Scan the QR code to automatically open a web browser and the data mirroring IP address. The webpage will open to a blank Flex NX data collection screen. GPR data will not be visible until you enter Collection Mode and begin collecting data.



If using a computer connected to the Flex NX SSID, type the displayed URL (<http://192.168.8.1:3000>) into your web browser. As above, a webpage will open to a blank data collection screen and will populate once you start collecting data.

Tap Done to return to the Main Dashboard.

The data collection screen simply mirrors the data displayed on Flex NX, including Stacked Mode and Channel 1 or Channel 2 Modes. Start and stop file functions and target marking are not possible. Backup cursors will be visible, and pinch/zoom actions are available.



Data collection can be live-shared using an internet-connected device and a variety of 3rd party applications, such as FaceTime. GSSI does not guarantee the quality or performance of live streaming from 3rd party applications.

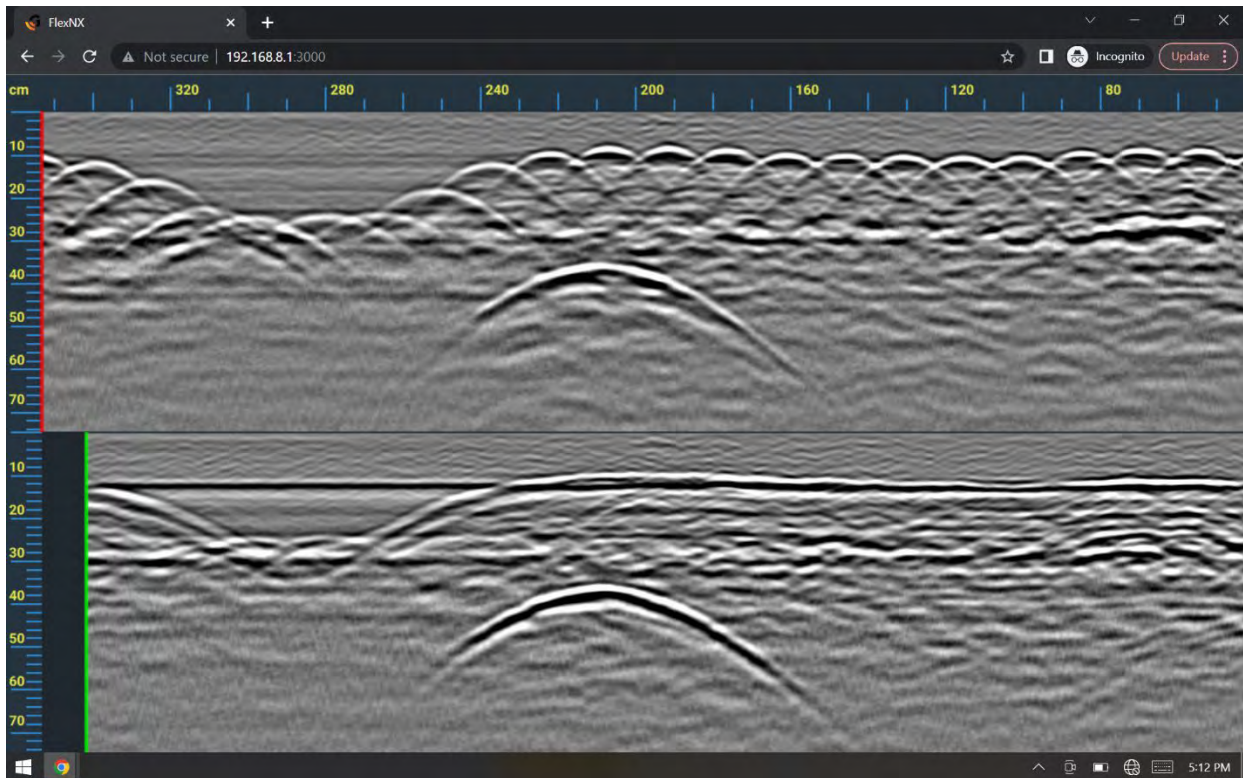

Flex NX data collection mirrored to a tablet. Data mirroring will appear similarly on most devices.

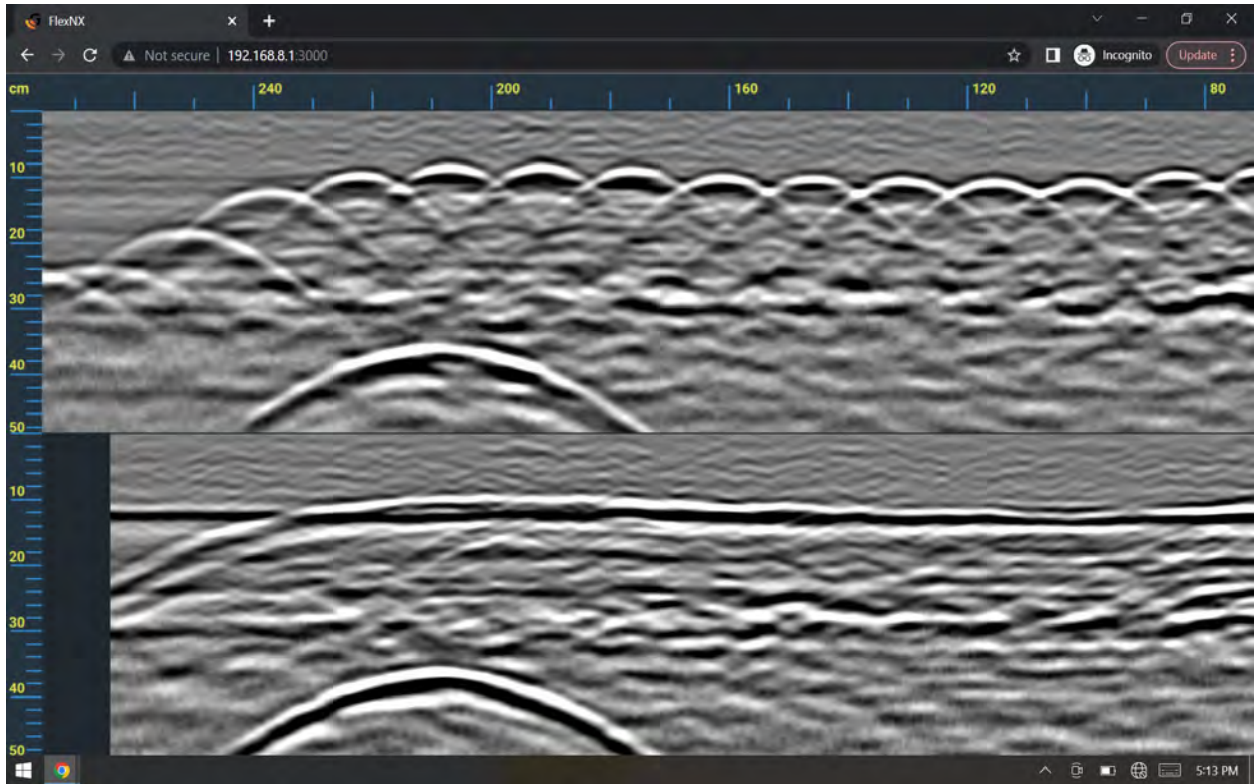

Screen mirroring using pinch/zoom interaction.

Technical Support

From the Flex NX Main Dashboard, tap the Technical Support icon. Scan the QR code to open the GSSI Technical Support page.

You may also call the number provided to speak with a member of our Technical Support Team.

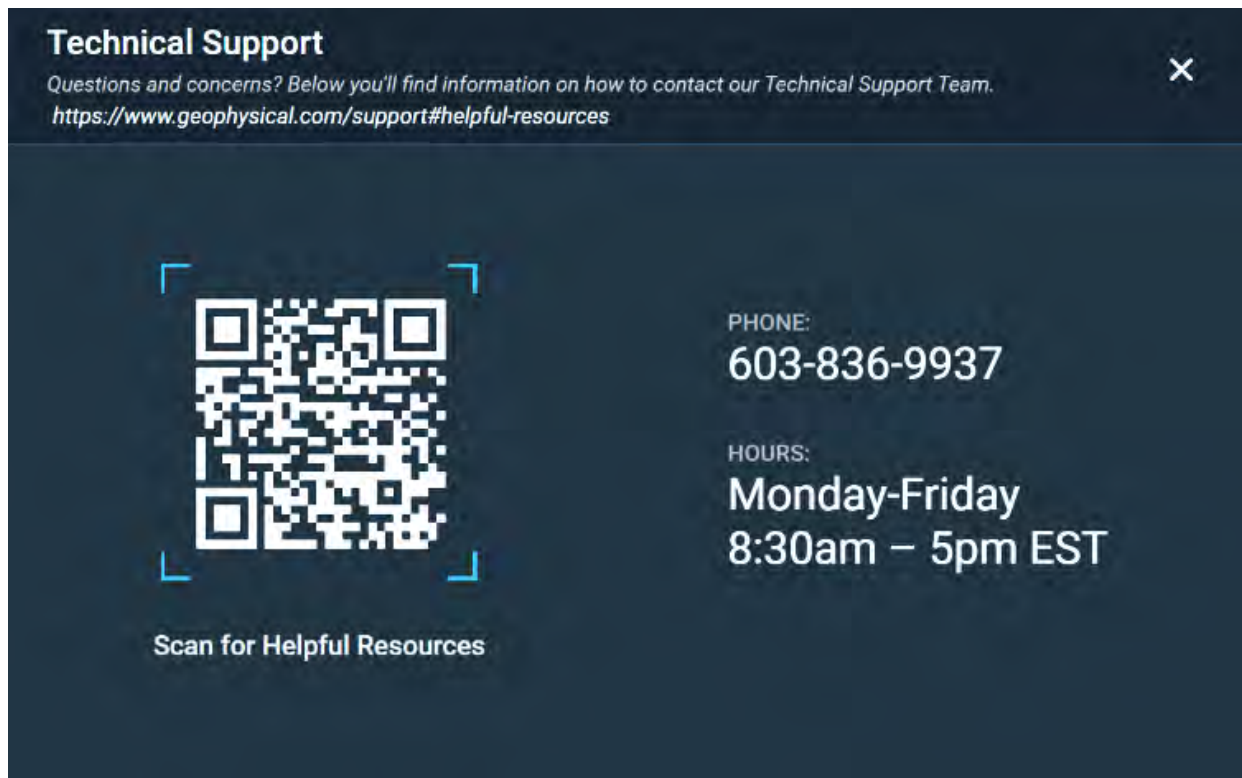

Technical Support ×

Questions and concerns? Below you'll find information on how to contact our Technical Support Team.

<https://www.geophysical.com/support#helpful-resources>



Scan for Helpful Resources

PHONE:
603-836-9937

HOURS:
Monday-Friday
8:30am – 5pm EST

Please feel free to email training@geophysical.com with any questions, comments, or feedback.

Project Management

Flex NX's project management structure integrates seamlessly with GSSI Fusion, allowing you to easily transfer Fusion-ready data and results from Flex NX to your personal device. Flex NX and Fusion projects are designed around a unique project folder, and the ability to create multiple Areas of Interest within a project. Use this to your advantage on job sites with multiple working areas. Keep projects organized by creating individual project folders and Areas of Interest, and then save scan data and results into these areas. You can then upload your data to GSSI Fusion.

Projects Portal

Access the Projects Portal from the Main Dashboard's Top Navigation Menu by tapping the folder icon in the upper left corner.

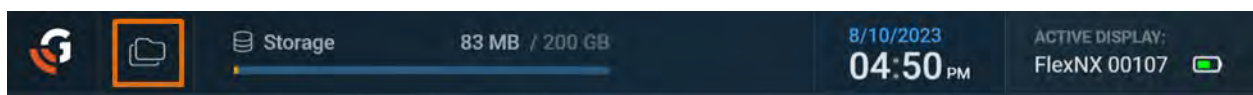

Creating New Projects

Open the Projects Portal to view saved projects. You may then open an existing Project Profile by tapping a folder or create a new project by tapping the Create New Project icon. A confirmation will appear once a new Project is created.

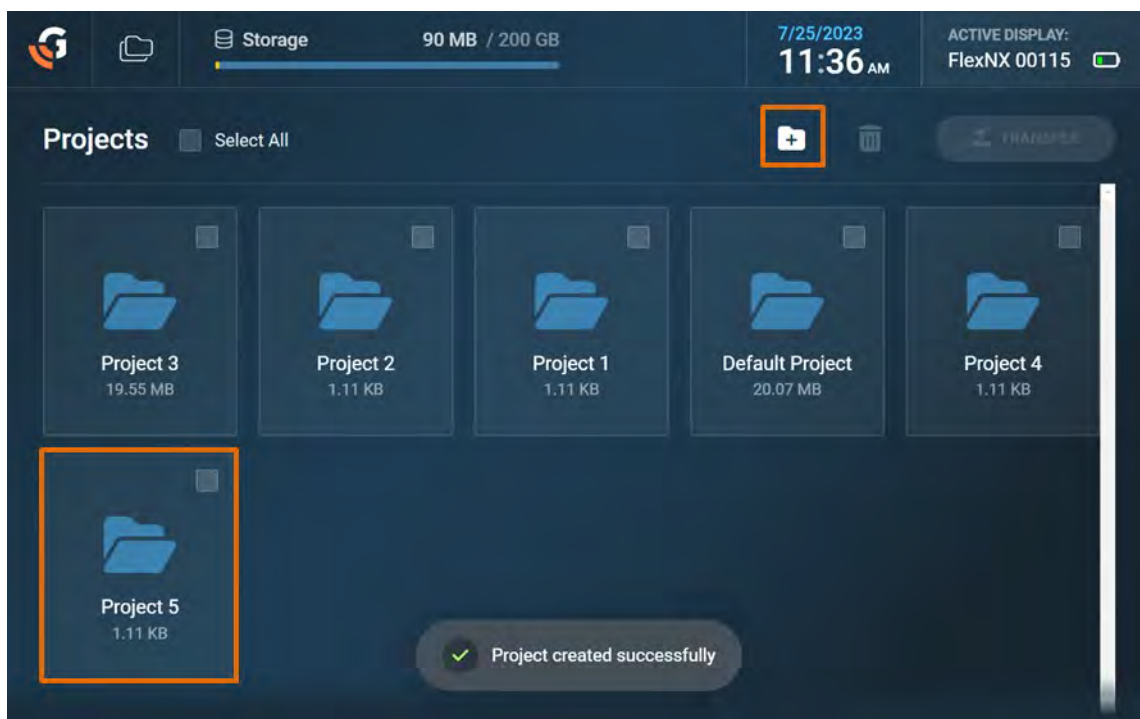

Alternatively, create a new project from the Main Dashboard's Recent Projects Pane.

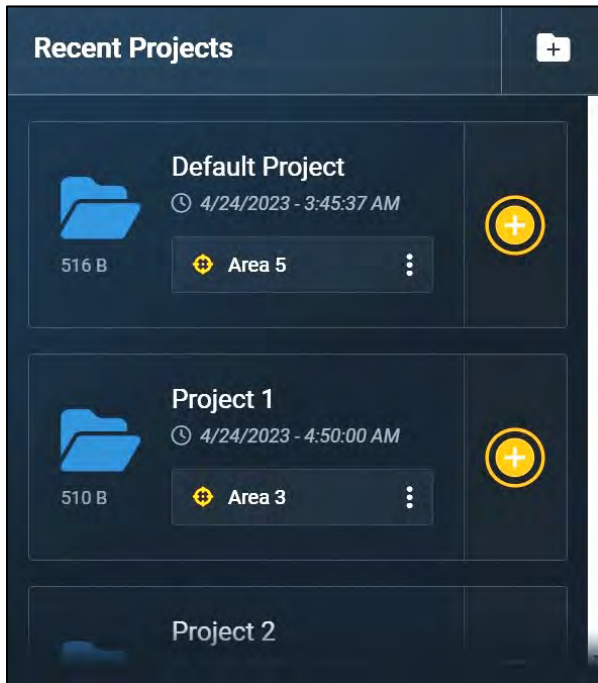

From the Main Dashboard, tap the Create New Project icon. A new project will be generated.

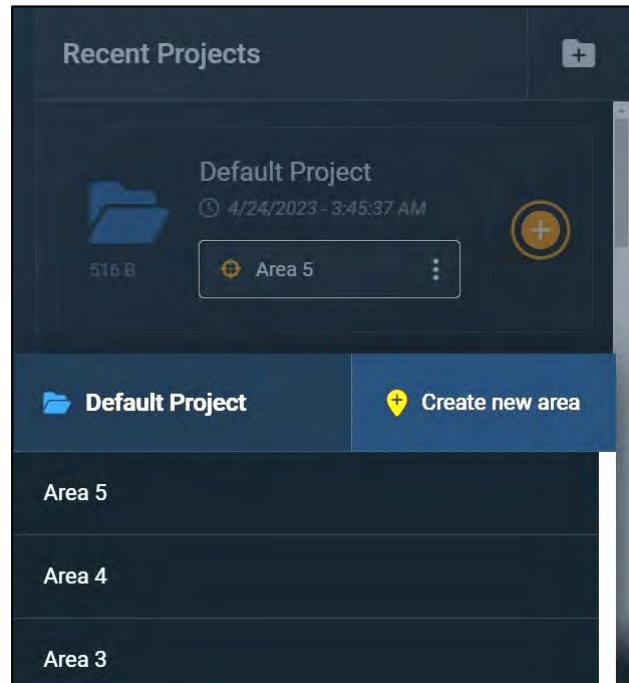

To create a new Area of Interest in a project, tap the stacked 3-dot icon, then tap Create new area.

Flex NX's project management system streamlines report generation in GSSI Fusion. Make sure to spend the time organizing your projects around Areas of Interest. When you upload your projects to Fusion, your data will already be organized and ready for report creation.

Project Profile

Tap any existing folder on the Projects Portal to open the associated Project Profile. Toggle between Areas of Interest to view saved Results and Scan Data.

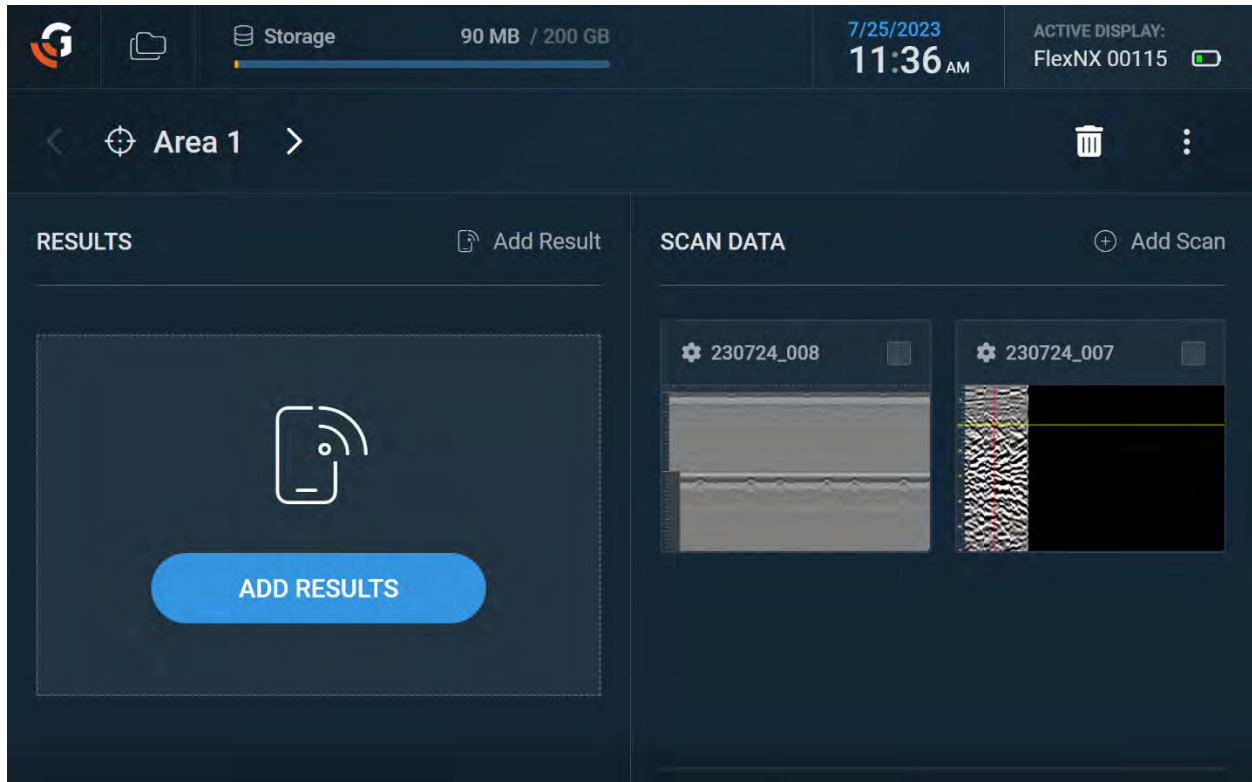

Results will typically be screengrabs taken during data collection. Select an image in the Results section to open it in a viewer.

Scan data are GPR data files that have been collected and saved to a folder. Tap Add Scan to collect a new data file within the current Area of Interest. You can also select a data file to open it in Playback Mode.

Select Results or Scan Data to perform file management. New icons appear once files are selected.

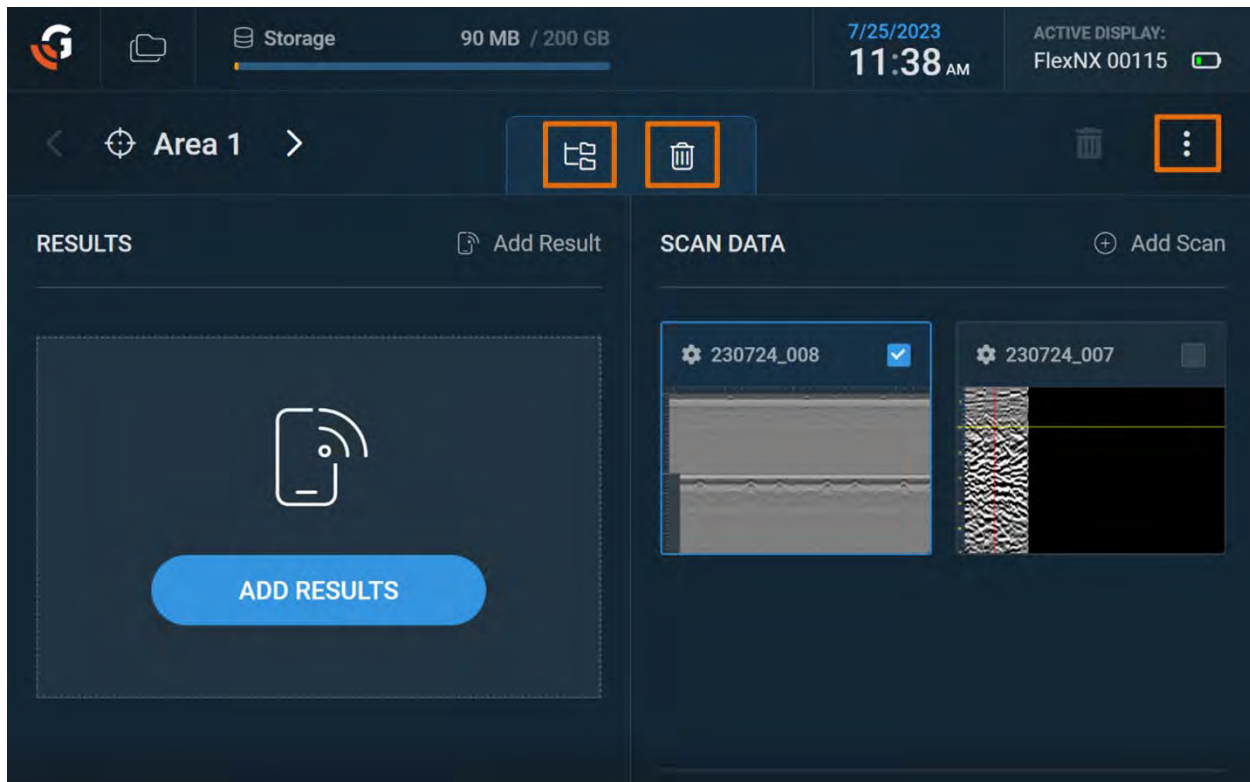

Select one or more data files to transfer to another Area of Interest, then tap the File Management icon.



You may also select one or more files and permanently delete them using the Trash Can icon.

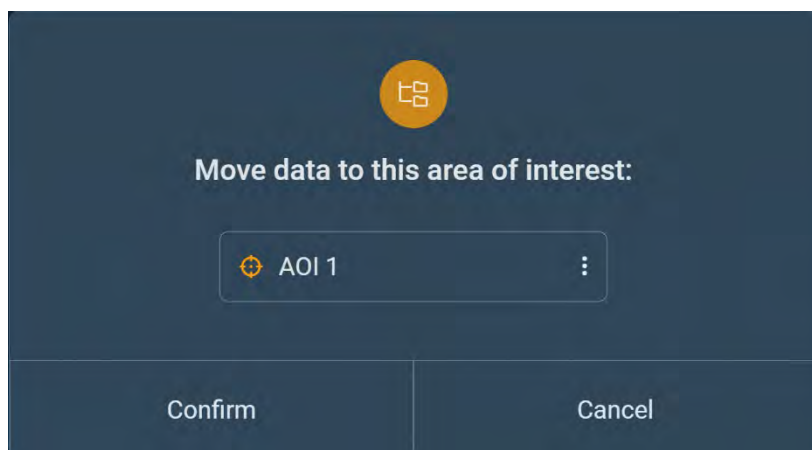

Please note that deleted files cannot be recovered.

Results and Scan Data cannot be moved to different Project folders; they can only be moved between Areas of Interest within a single Project. Use GSSI Fusion for greater organizational control.

To manage Areas of Interest, tap the stacked 3-dot icon in the upper right corner.

To change the area of interest, tap the three dot stack menu icon at the top right of the screen. Select an existing area of interest or tap Create new area to add a new area of interest.

You can also delete an Area by tapping on the Area and selecting Delete Area.

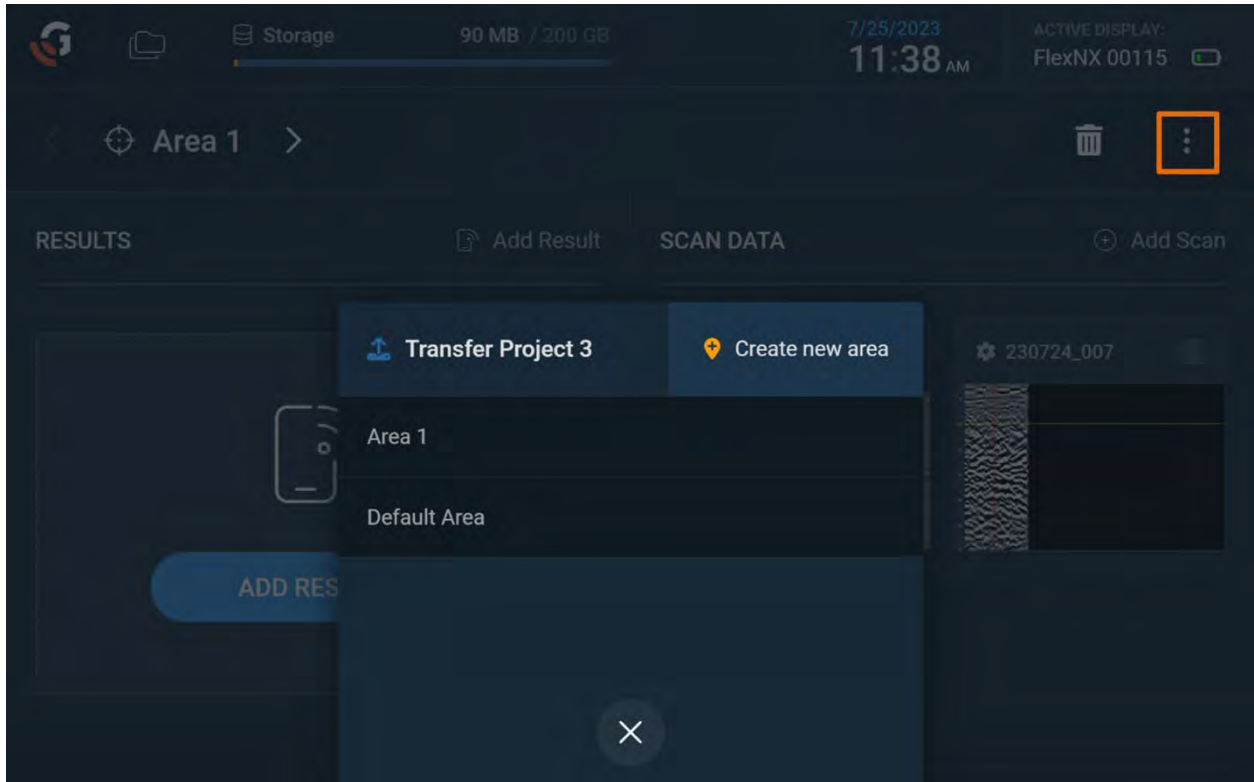

Transferring Data

You can transfer data from the Projects Portal (one or more Projects) or an individual Project Profile (a single Project) using a USB drive or via Wi-Fi to a smartphone or personal computer. Scan Data are packaged into .ZIP file archives containing .DZT files (raw GPR data), user marks stored in .GSSI files, and Results images captured during data collection or Playback. Future software updates will enable the pre-packaged and organized GSSI Fusion format.

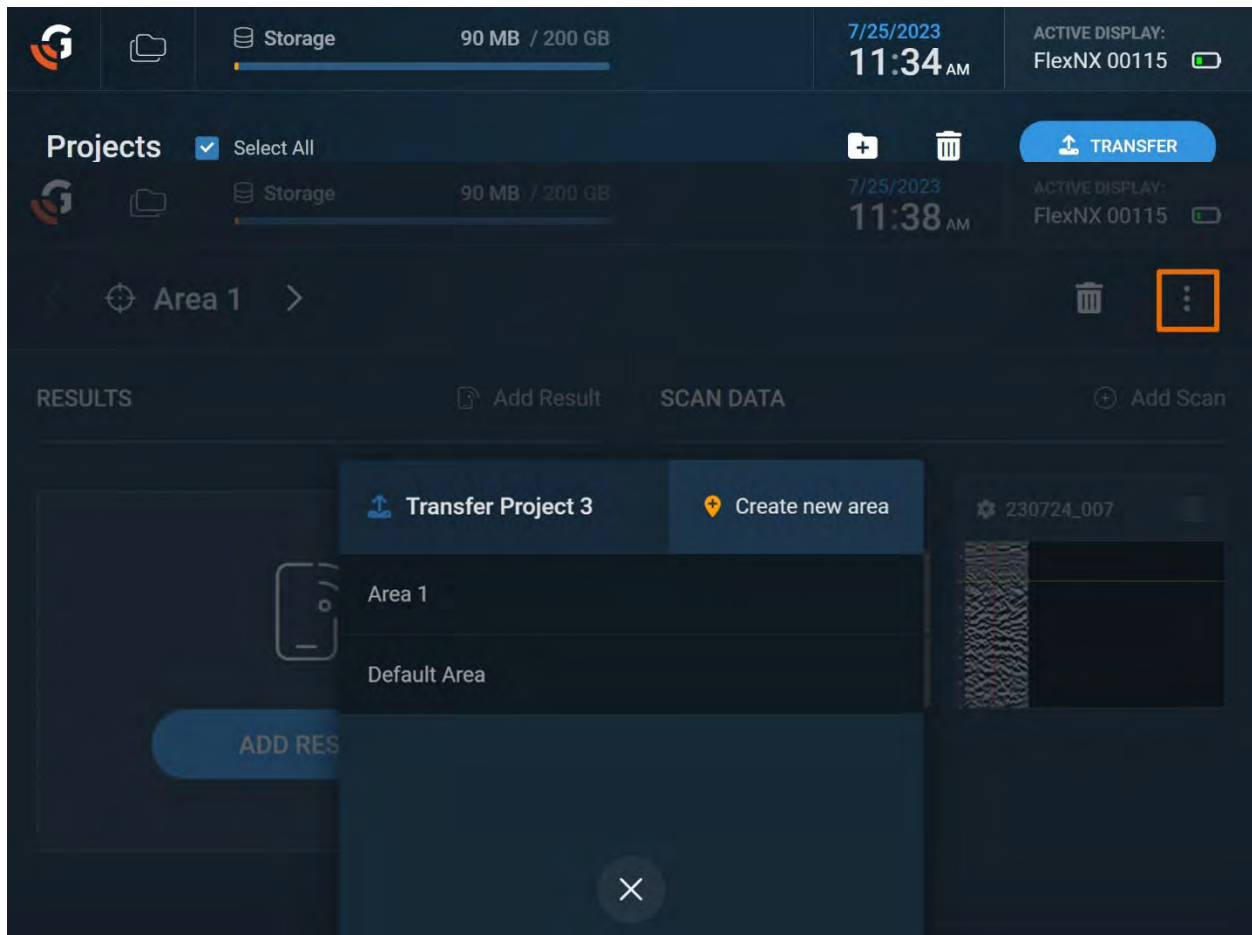

Option 1: Select one or more Projects from the Projects Portal to activate the Transfer icon.

You will then be prompted to choose between Scan Data and Fusion formatted data (to be released in a future software update).

Tap one of the formats and then tap Create Zip.

Option 2: Access a Project Profile by tapping a folder in the Projects Portal. Next, tap the three-dot stack menu icon at the top right of the screen, and then tap Transfer Project XX. You will then be prompted to choose between Scan Data and Fusion formatted data (to be released in a future software update).

Transfer Options 1 and 2 converge at this point and the remaining transfer process is identical. Continue data transfer by tapping one of the formats and then tap Create Zip.

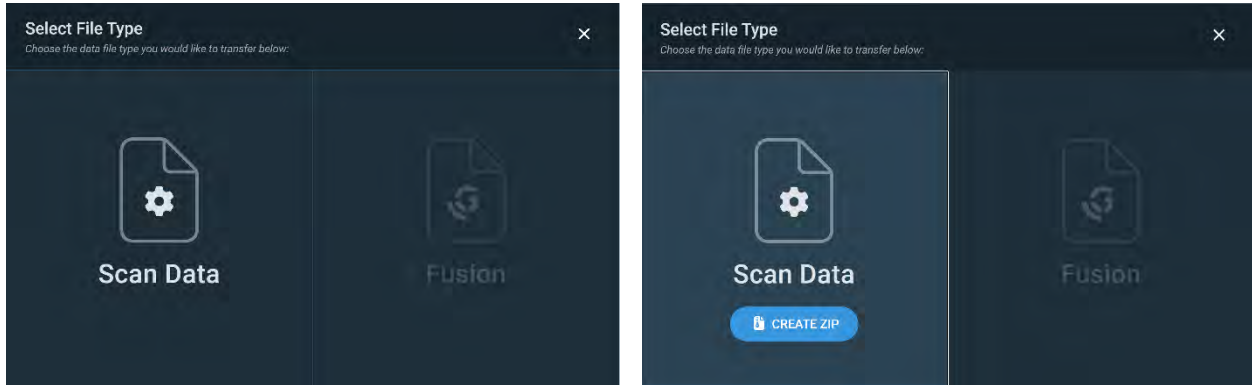

Flex NX will begin creating the .ZIP file and will display a progress bar.

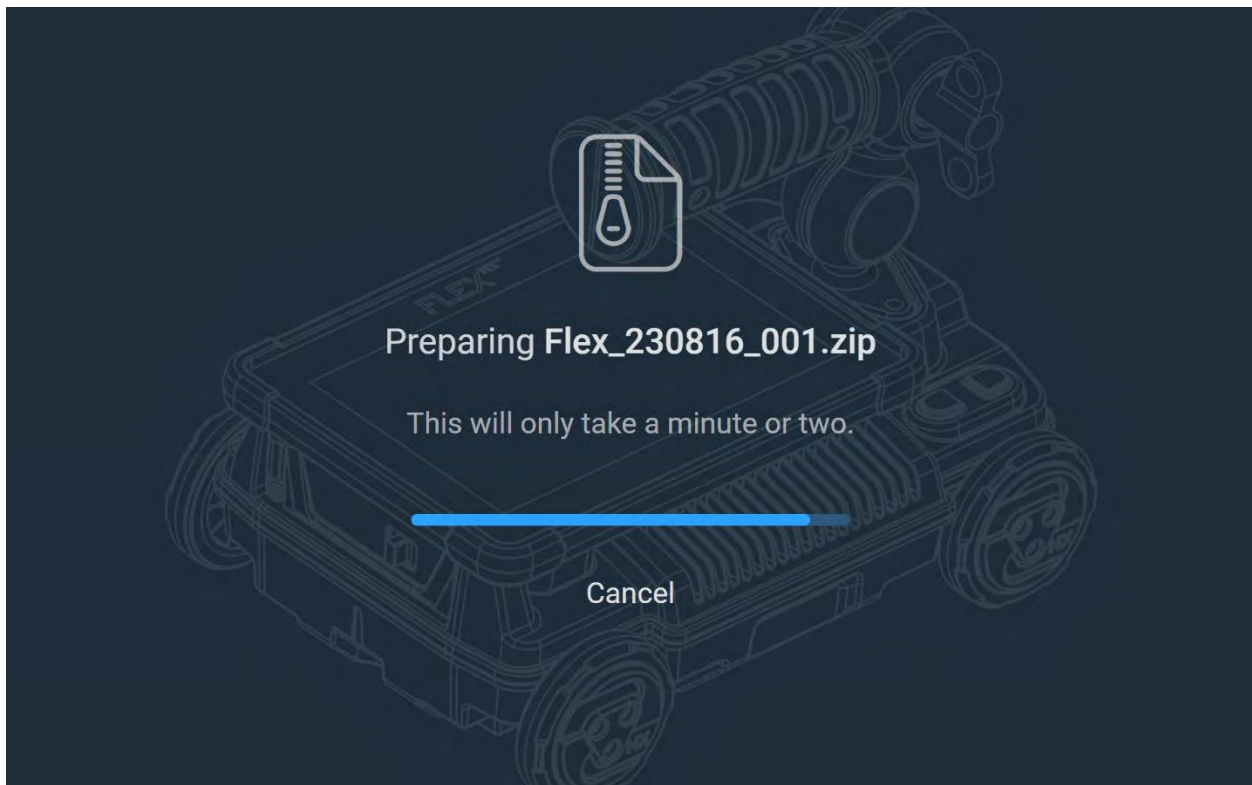

Once the .zip file is prepared you'll be prompted to select Mobile (Wi-Fi) or USB transfer.

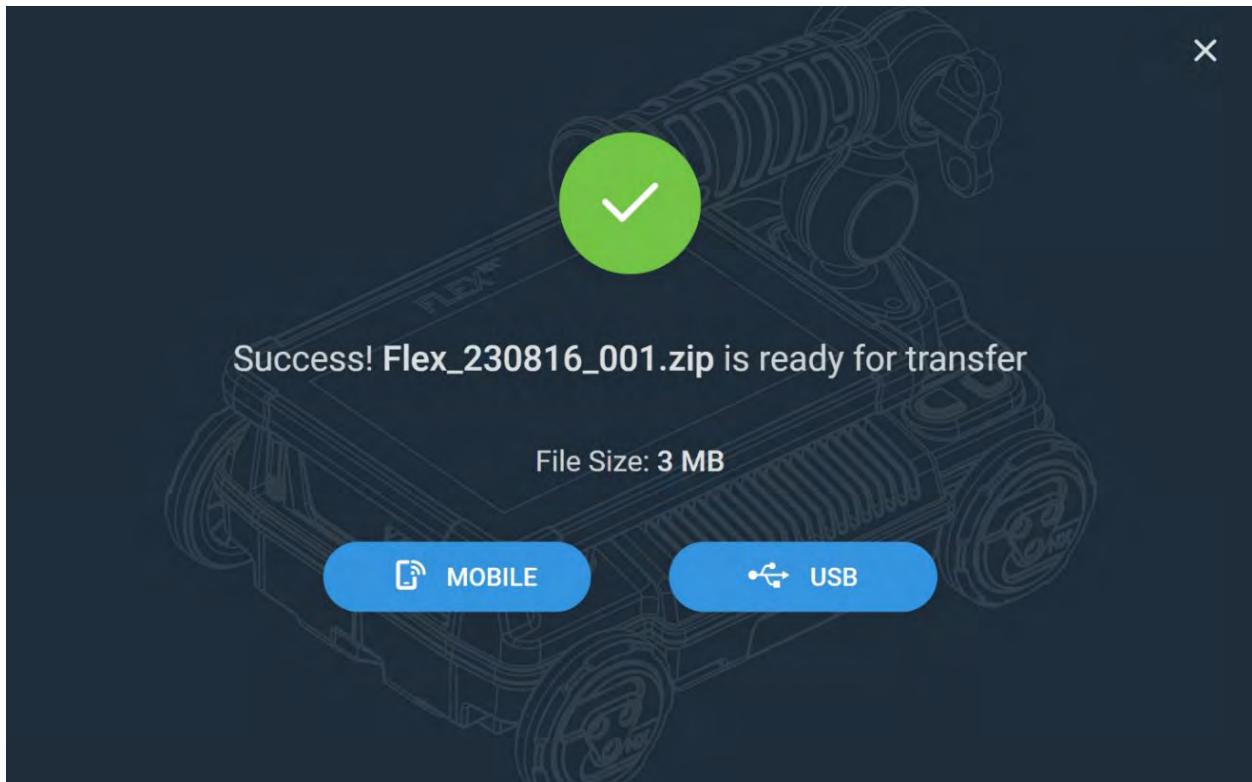

Wireless Transfer

Tapping the Wireless Transfer option generates a QR code you can scan with a smartphone. Your device will then be connected to the Flex NX network. Tap Next.

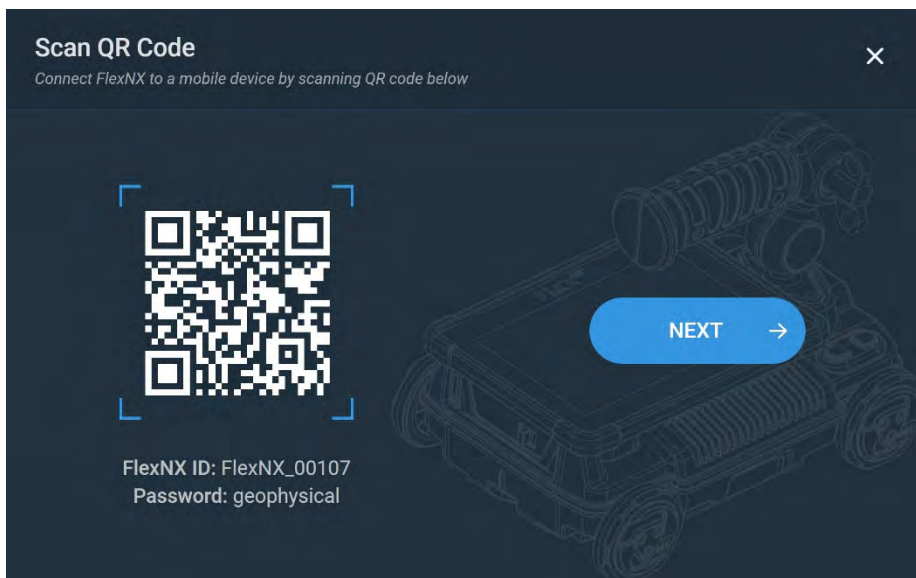

If your device cannot scan QR codes, you must manually connect to the Flex NX network. Once connected, click Next on Flex NX.

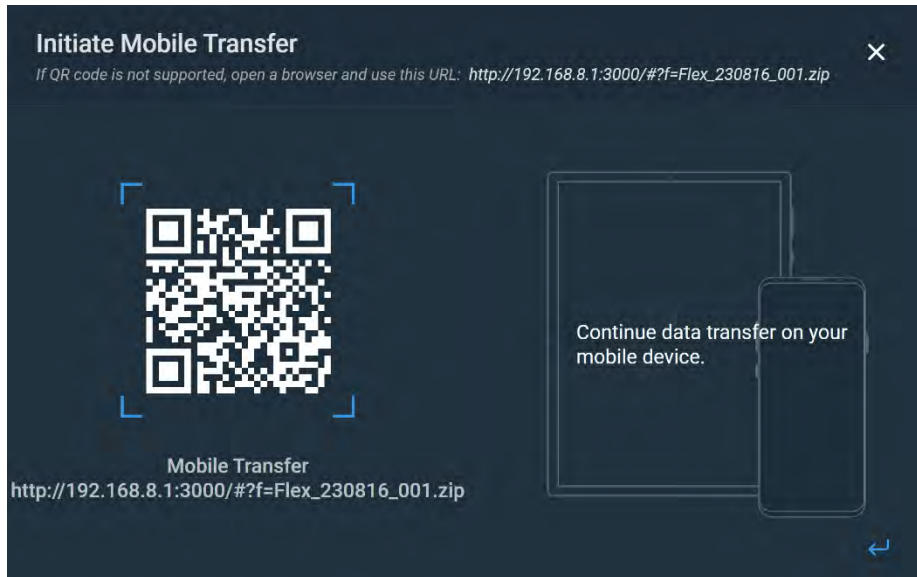

Scan the QR Code to open a web browser. The wireless transfer address will be added to the web browser's address bar, and the browser will open a new page.

If using a device that cannot scan QR codes you must manually type the address into your web browser.

Click Initiate Transfer to begin downloading the .ZIP file. The download behavior is just like any other browser download. Depending on your browser settings, the file may automatically save to a downloads folder or you might be prompted to choose a local directory.

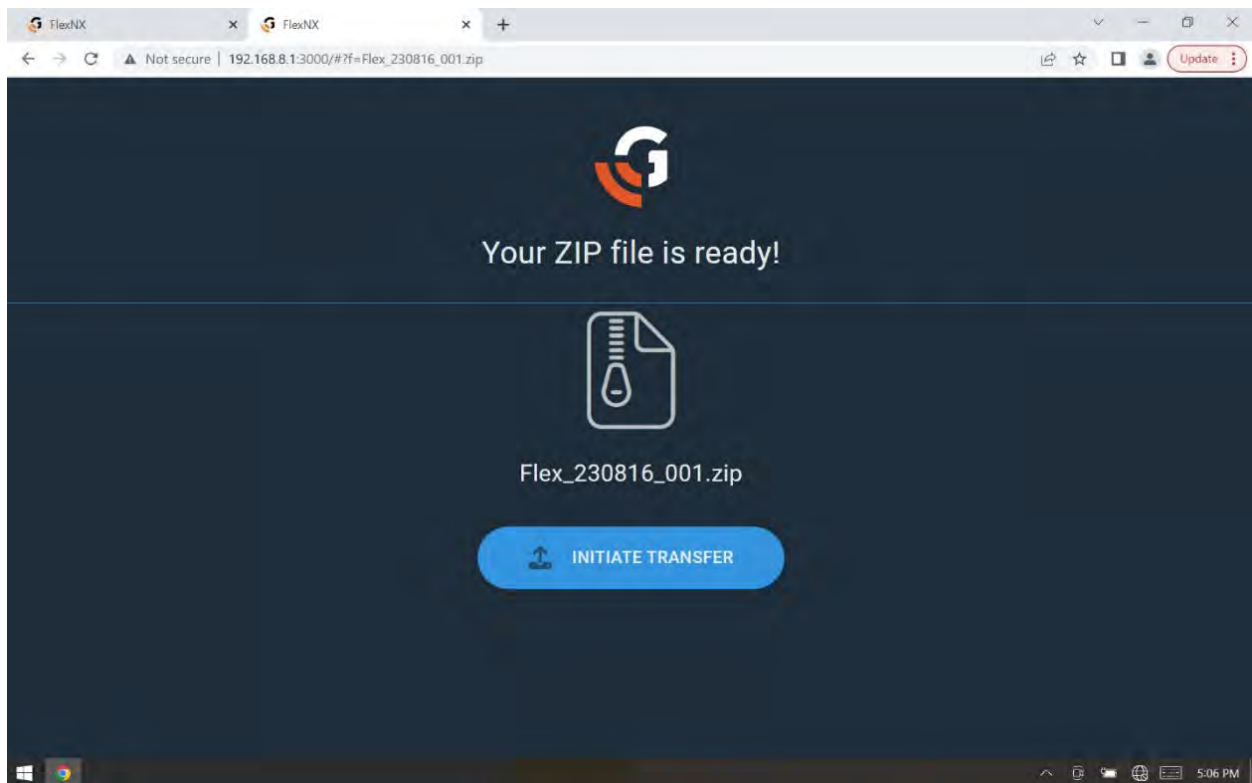

USB Transfer

Tap USB to transfer the .ZIP file to a USB device, such as a USB flash drive.

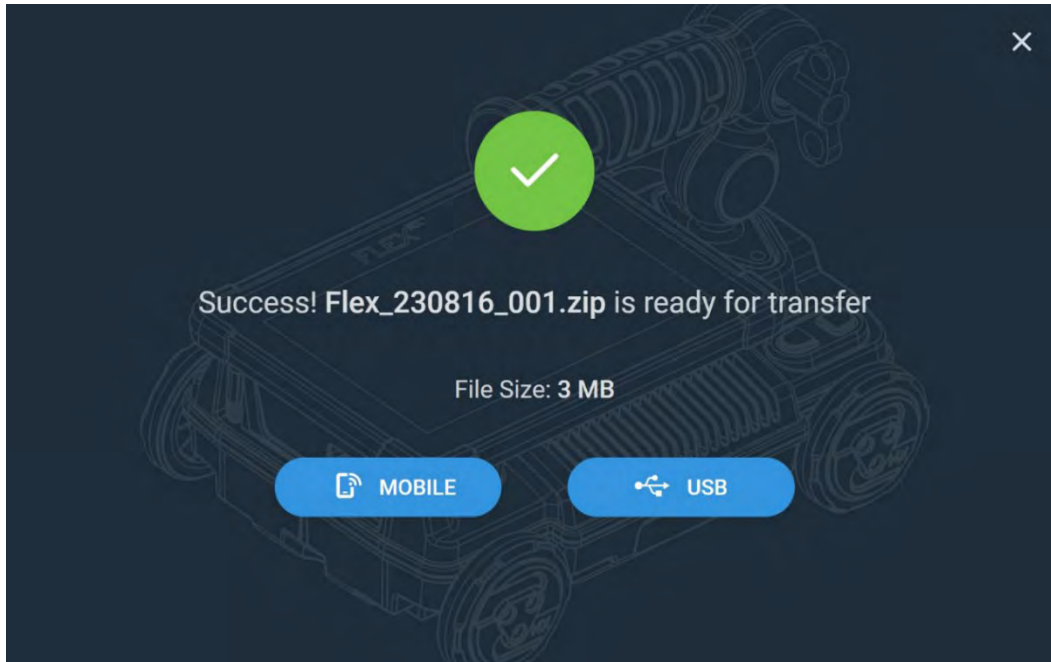

A USB screen will appear if a USB device is not inserted or detected. This may also occur if your USB device is formatted incorrectly.

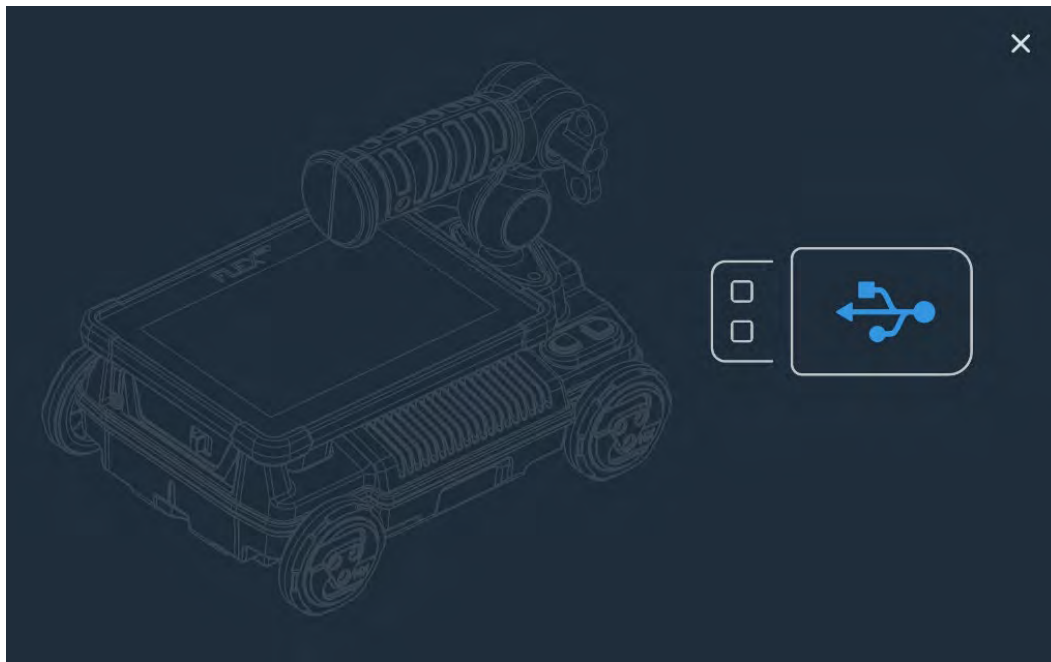

Flex NX will begin transferring data once a USB device is detected.

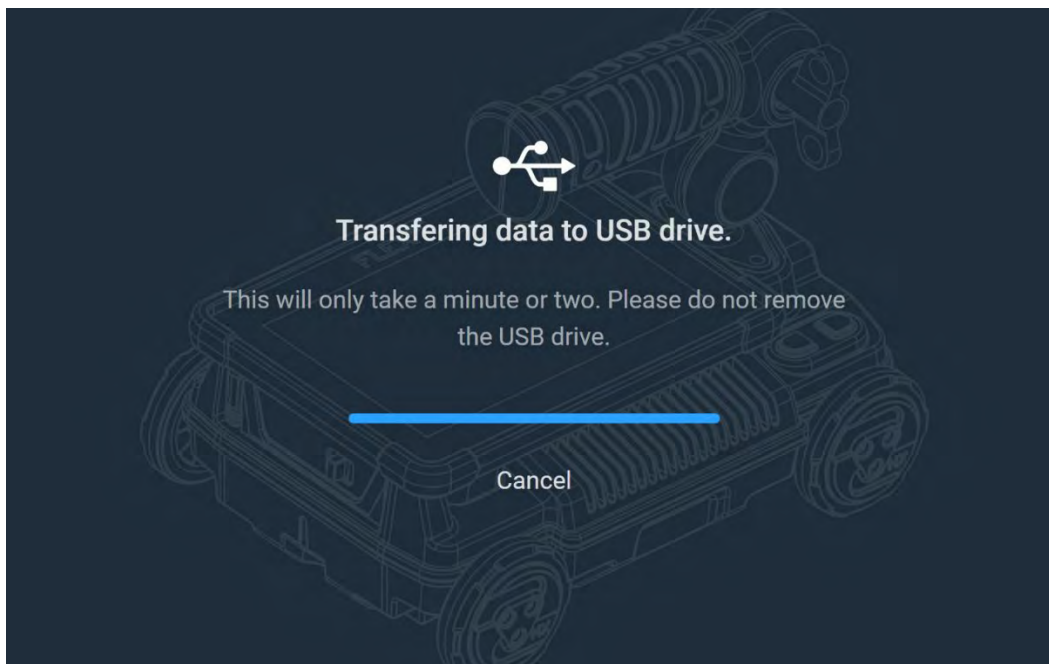

You can remove the USB device when data transfer is complete. Tap Done.

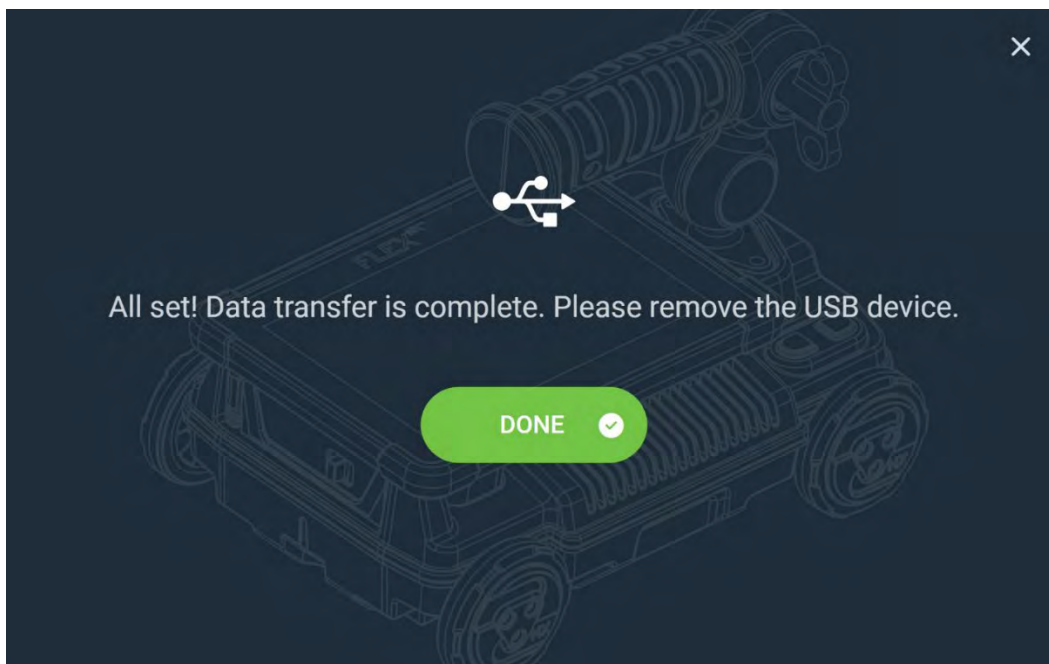

Collecting Data with Flex NX

Scanning and Marking Overview

When using GPR to scan concrete, the objective is to identify objects within and below the slab and to accurately mark their location on the surface. This helps drillers and saw cutters avoid damaging reinforcement, utilities, and other slab and subgrade installations.

This is generally accomplished by collecting GPR data in a 2ft x 2ft grid pattern around each core penetration, or within a foot on either side of the entire linear distance of a saw cutting line. The lasers on the side of Flex NX show the center of each antenna so you can align the onscreen backup cursors with a target. You can then accurately translate the target's location onto the slab surface using chalk, tape, or a wood crayon. Mark linear features in at least three places so you can capture their layout.

GPR cannot reliably determine the diameter of targets, so be sure to include extra width when marking reinforcement, conduit, and other targets. GPR scanners often use black for reinforcement and red for conduit. You can use other colors as needed, but red should be reserved for conduit. When using non-standard colors, reserve a dedicated, bright and highly visible color for conduit markouts.

A more in-depth description of scanning and marking techniques can be found in the Additional Resources section (Page 59) of this manual.

Before You Scan

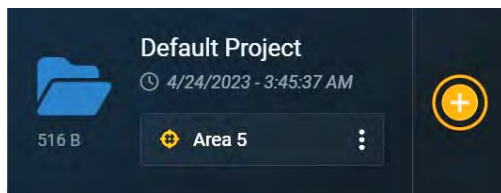

To quickly start a new scan from the Main Dashboard, tap the Start New 2D Scan icon in the project folder of your choice. This action will bring up the Select Concrete Type screen.

You can also start a new scan by opening a project folder from the Projects Portal. Tap Add Scan to proceed to the data collection screen.

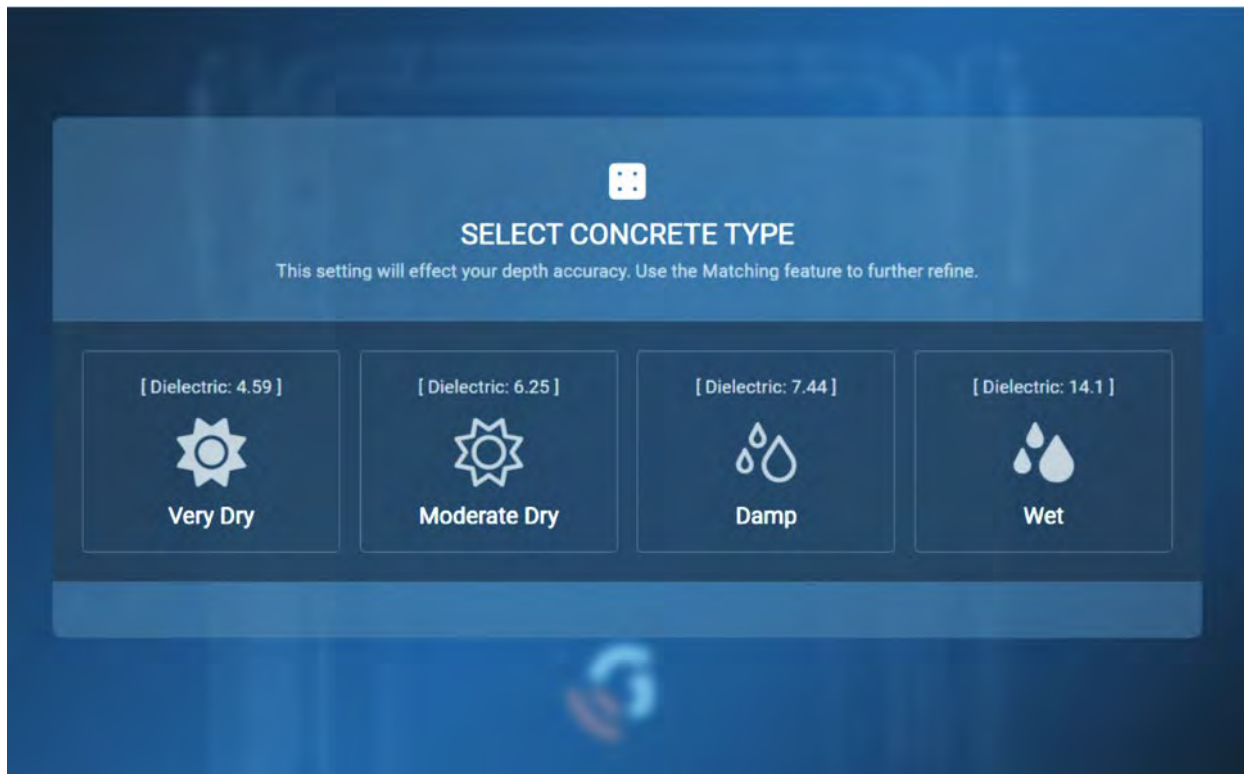

Select a concrete type that best represents your working conditions. This setting will affect your depth accuracy. This screen will only appear once during each scanning session.

Select from Very Dry, Moderately Dry, Damp, or Wet concrete types.

Use your knowledge of the age of the slab. If the slab's curing state is unknown, consider using the Matching feature (see Depth Panel sections) to refine the depth scale.



Dielectric constant, or relative dielectric permittivity [RDP], is a measurement of a material's ability to store, and then transfer, electromagnetic waves. By selecting a Concrete Type you are setting an estimated dielectric constant, which could improve the depth accuracy of objects in your data. Use the Concrete Cure screen for an initial benchmark, then further refine the dielectric (and your depth scale) using the Depth Panel options in Collection Mode.

Data Screen and Basic Collection

The Data Screen is where you collect 2D profiles, place user marks, and save screenshots.





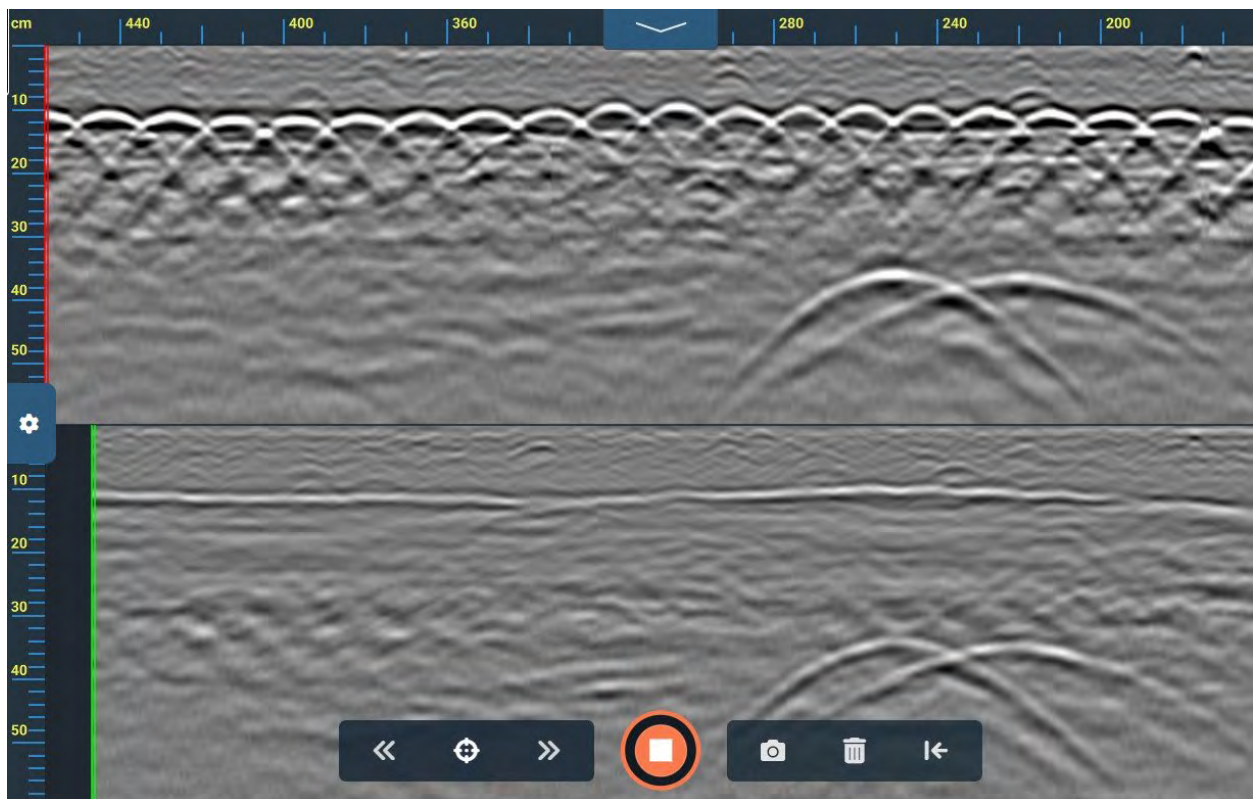



Tap the Start Scan icon to begin a new scan. The icon will now have a white square at its center. The data screen will remain blank until you push Flex NX forward to begin collecting data. The profile will begin building from left to right on the screen. The filename is displayed in the Top Navigation Panel (minimized by default) and is named using the current date and an affix representing the scan number.

Stacked Mode is the default display method, showing both the standard orientation antenna (top) and the cross-polarized antenna (bottom). As you collect data you will notice an offset in the two profiles. This offset represents the physical distance between the two antennas. Move the system in reverse to see backup cursors: **red** for standard orientation (front antenna) and **green** for cross-polarized (rear antenna).



You can playback a file by opening it from the Project Profile screen. The playback and collect screens are identical and offer the same range of functionality. When finished with Playback, simply tap the New Scan icon to collect new data.

The Data Collection screen features the following functions:

Navigation Menus	
	Top Navigation Access Icon. Tap to access Return to Dashboard, Active Project options, Area of Interest options, File Information, and Current Display options. Tap again to minimize the Top Navigation Panel.
	Side Navigation Menu. Tap to access the Gain, Display and Depth panels. See Gain, Display and Depth sections below for more information. Tap again to minimize the Side Navigation Menu.
Data Collection Controls	
	Start/Stop Scan. Tap to start collecting a new scan. Push Flex NX forward to begin building a GPR profile.
	Previous Target/Next Target. Toggle between user marks, displaying the depth and distance traveled information. You can also edit or delete the user marks.
	Target Marking. Use your finger to drag and place the crosshair on a feature of interest, then use the Target Marking menu to place a user mark. You can change the color of your user mark before saving it. Tap again to exit Target Marking mode.
	Screen Grab. Tap this icon to take a screenshot of the on-screen data. The Flex NX system will save the screenshot as a PNG image file for later transfer. Screen grabs are saved to the Results section of the current Project and Area of Interest.
	Delete Current Scan. Tap to discard your current scan.
	Reset Cursor. This function will reset the cursor to the end of the current scan. You can then resume collecting data without starting a new file.









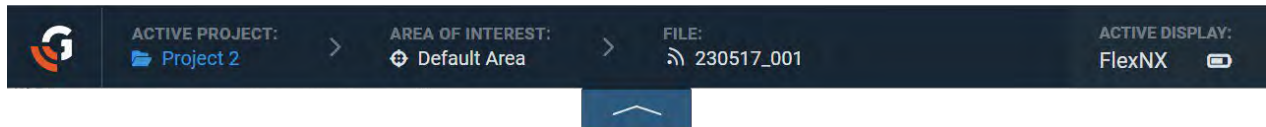

Pinch Zoom and Pan: You can zoom in on features by using two fingers. You can return the screen to its original zoom level, or zoom in further, by moving your fingers apart. When zoomed, drag one finger to pan the display right, left, up, and down. Pinch zoom and pan affect both channels in Stacked Mode.

Top Navigation Panel

The Top Navigation panel, located at the top of the screen, can be accessed during data collection by tapping the upward arrow. Tap the arrow again to minimize the menu.



 Tap the Top Navigation Access icon to display the following:

Top Navigation Icons and Controls	
	Return to Main Dashboard. Tap to exit collection and return to the Dashboard.
ACTIVE PROJECT:  Default Projec...	Active Project. Tap the arrow icon to view the current project's saved content. From here, you can access results and scan data saved to Areas of Interest.
FILE:  230502_013	Current File. View the name of the current file. Data files are named incrementally based on the calendar date and the order of collection. The naming prefix uses two numbers each for day/month/year, followed by an underscore and the file number.
AREA OF INTEREST:  Area 3 	Area of Interest. Tap the arrow icon to change the Area of Interest. You will see Default if no Areas of Interest are available.
CURRENT DISPLAY:  FlexNX  	Current Display. View the currently active device and its battery status.

Side Navigation

Activate the Side Navigation panel by tapping the gear icon on the left side of the Data Collection screen. This panel is always accessible in the Data Collection screen before, during, or after data collection or while in Playback Mode. The Side Navigation panel contains the Gain, Display, and Depth panes. The icon for each pane is located at the bottom of the panel.

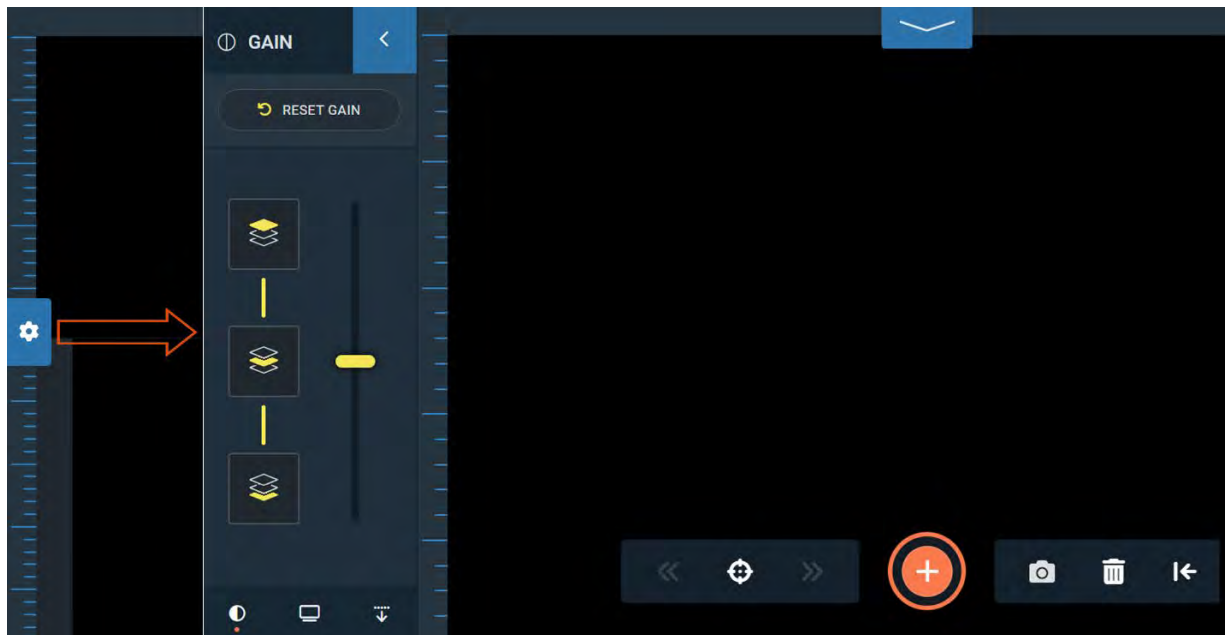

Side Navigation: Gain Panel

Use the Gain Panel to adjust the visual contrast of your data.

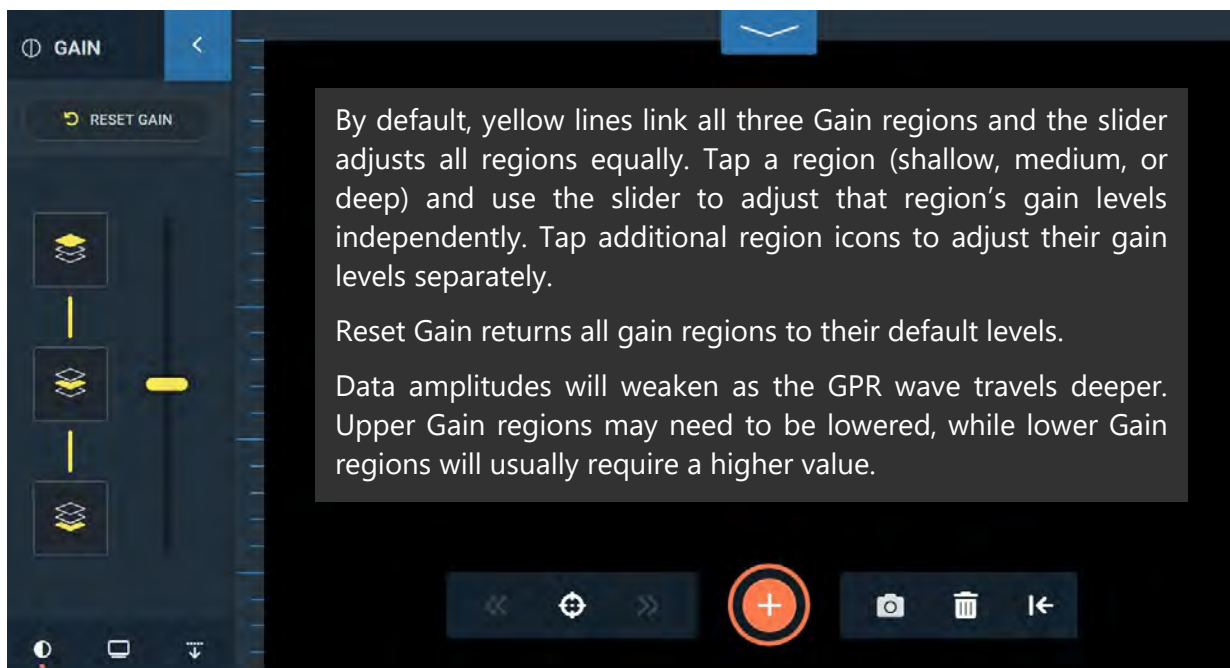

Side Navigation: Display Panel: Color Table Options Submenu

Use the Display Panel's Color Table Options submenu to select from a list of color tables.

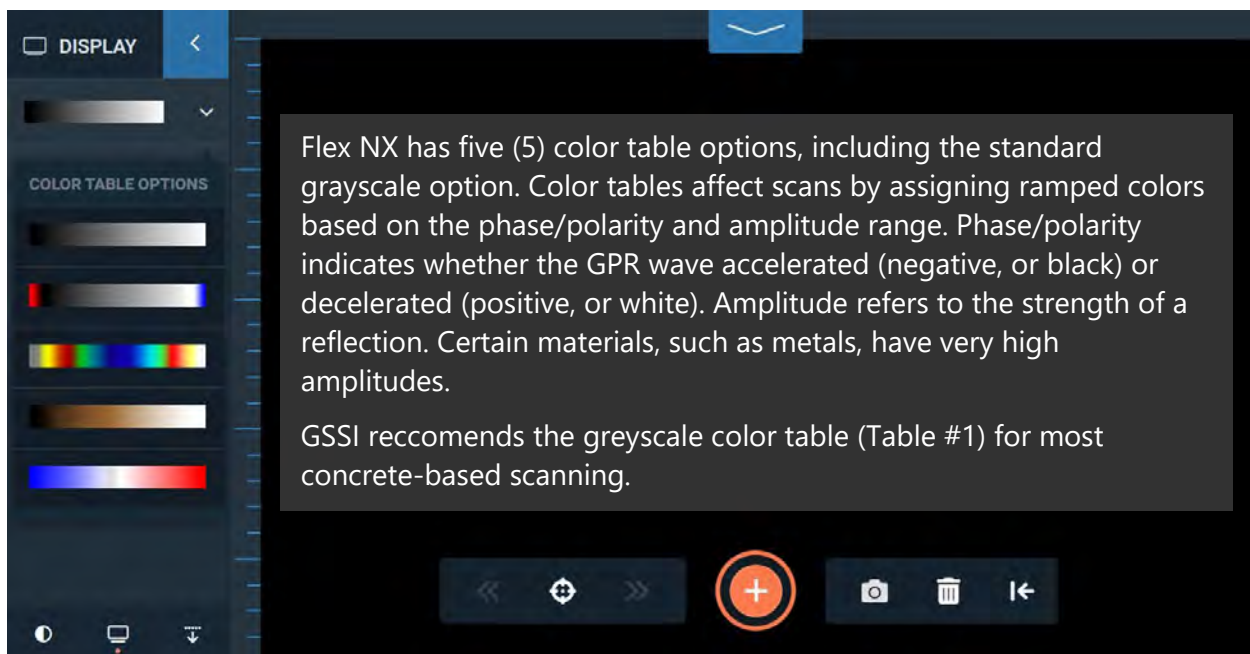

Side Navigation: Display Panel: Window Options Submenu

Use the Window Options submenu to access display modes and toggle the O-Scope and Focus Mode.

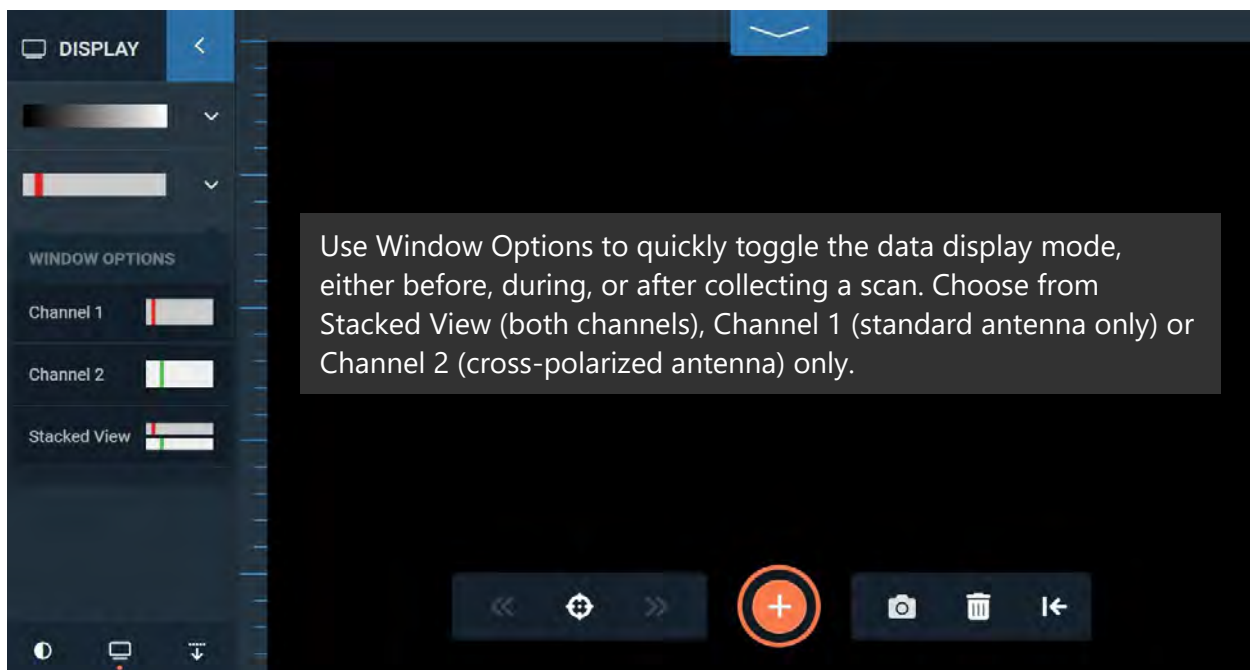

Window Options Submenu: Stacked View

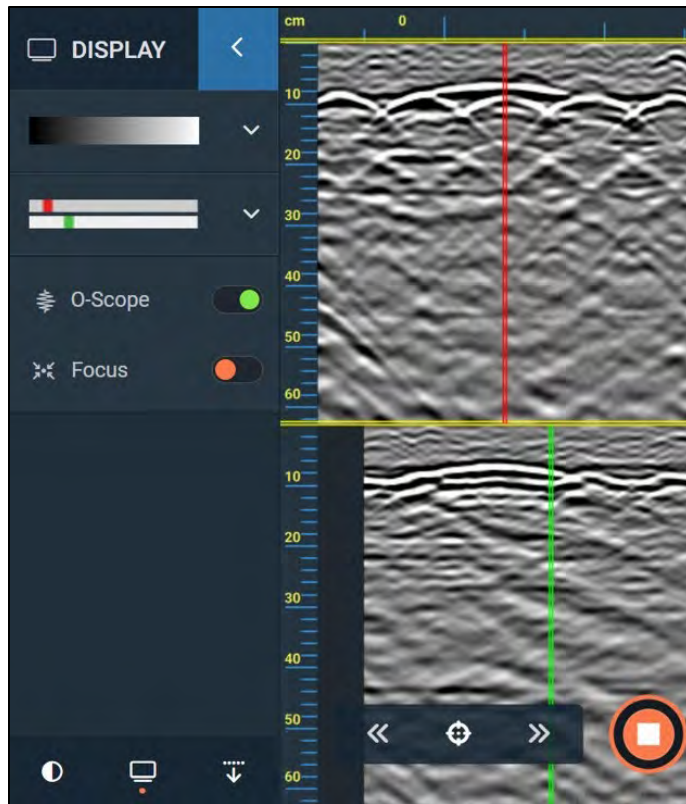

Stacked View displays both the standard antenna and the cross-polarized antenna

The front antenna (Channel 1, on top) is standard polarized and corresponds with the **red** backup cursor and **red** lasers.

The rear antenna (Channel 2, on bottom) is cross-polarized and corresponds with the **green** backup cursor and **green** lasers.

Use the Pinch Zoom function to zoom in on features of interest in both channels. When zoomed, use one finger to pan both profiles.

Window Options Submenu: Channel 1

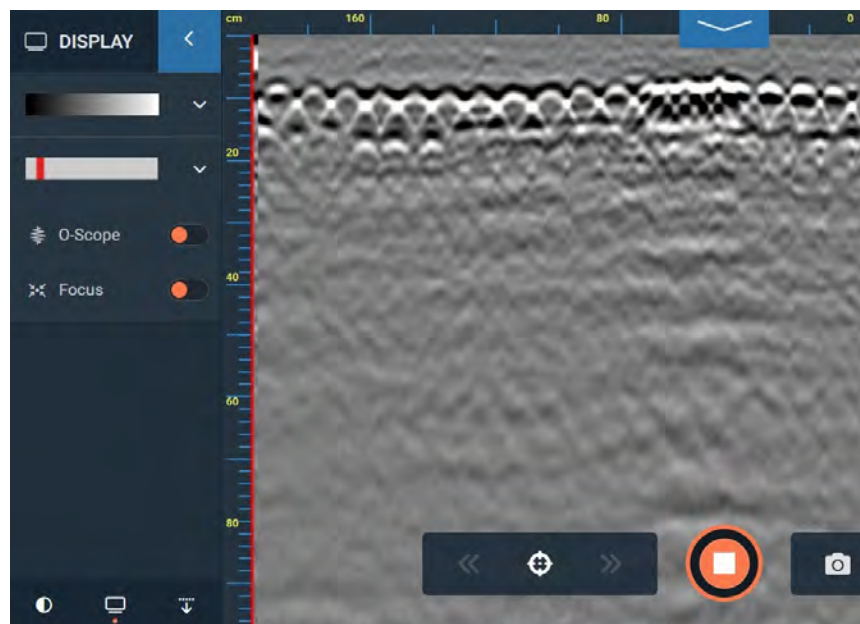

Selecting Channel 1 will only display data from the standard polarized antenna. Note the **red** back up cursor corresponds with the **red** side lasers of the standard antenna.

Additionally, with Channel 1 activated you will only see the **red** side and front lasers.

Use the Pinch Zoom function to zoom in on features of interest. When zoomed, use one finger to pan.

Window Options Submenu: Channel 2

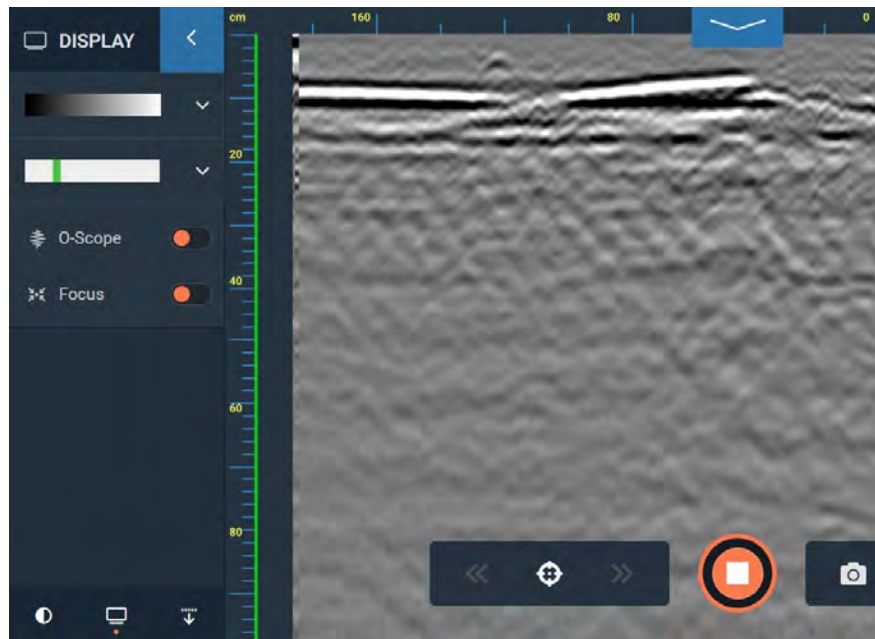

Selecting Channel 2 will only display data from the cross polarized antenna. Note the **green** backup cursor corresponds with the **green** side lasers of the cross polarized antenna.

Additionally, with Channel 2 activated you will only see the **green** side and back lasers.

Use Pinch Zoom to zoom in on features of interest. When zoomed, use one finger to pan.



Each antenna has individual, yet complimentary, strengths. The standard antenna is more sensitive to metallic targets, while the cross-polarized antenna can make it easier to resolve non-metallic targets. Use both antennas to make informed decisions.

Display Panel: Oscilloscope

The Oscilloscope waveform, or O-Scope, can be toggled on and off. When on, it will be displayed on the left side of the profile(s). With experience, the O-Scope can be used for a more nuanced analysis of the data.

The O-Scope displays the individual GPR trace associated with the backup cursor's current location. The vertical axis mirrors the scan's depth scale, with increasing depth from top to bottom. The width of the O-Scope peaks represents amplitude. Stronger reflections, such as from metal, create larger O-Scope peaks on both sides. Phase/polarity is represented by the peaks on either side of a centerline. Peaks to the right indicate normal phase/polarity, while peaks to the left indicate negative phase/polarity. GPR reflections always occur as a series of three peaks.

The O-scope is a visualization of the raw data collected by the GPR unit. With practice you'll find that the O-Scope is essential for advanced analysis and aligning the horizontal Target Marking line with a target's highest amplitude peak. It is also helpful to use the O-Scope when performing functions like hyperbola Matching and Set Depth. Lastly, the O-Scope can provide information on data quality, depth penetration, and the presence of external electromagnetic interference. Periodic external noise (such as cellular network communication) will make the trace look 'jittery' and jagged, while continuous external noise (such as radio and television transmissions) can cause the trace to shift off the centerline of the O-scope.

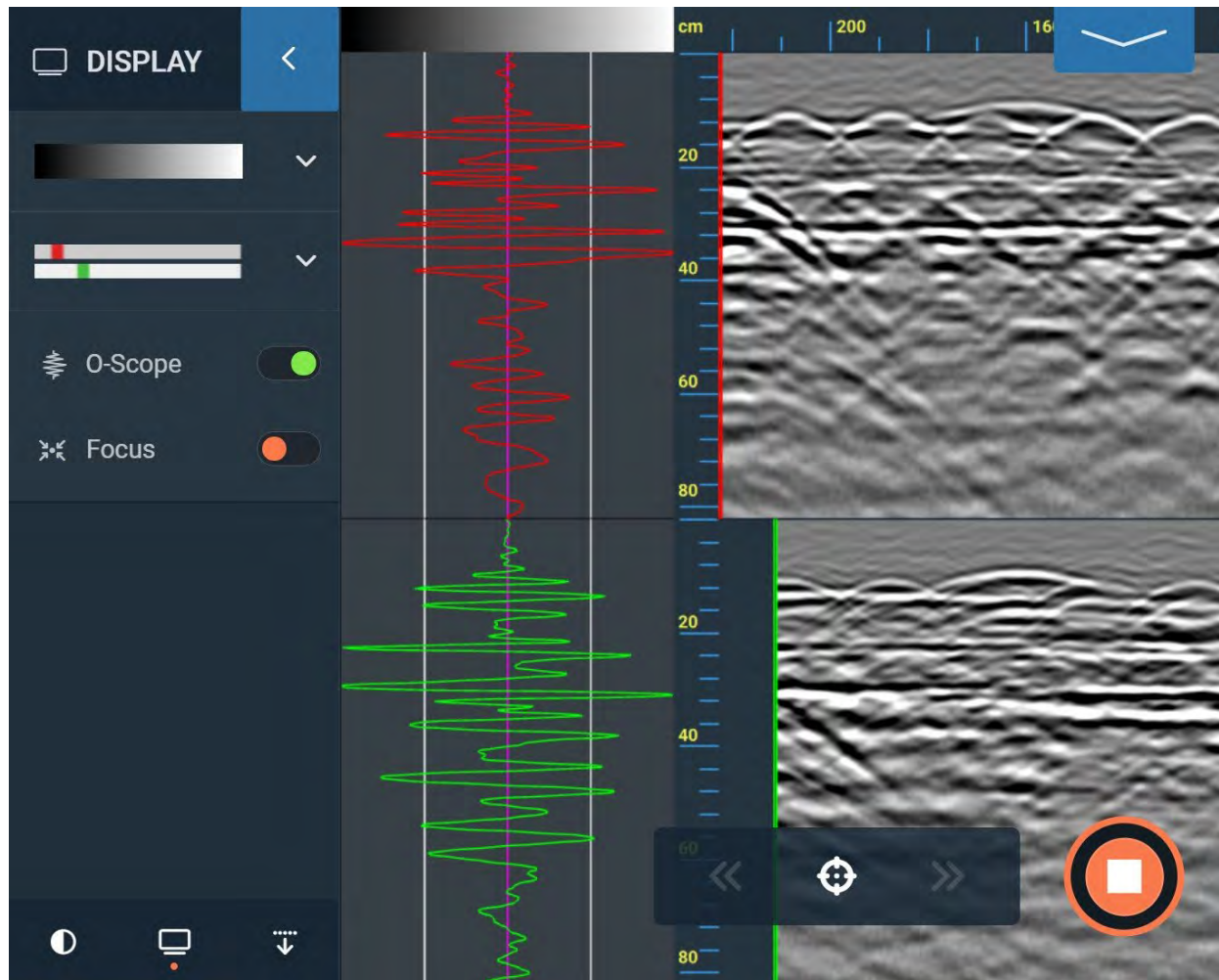

Side Navigation: Depth Panel

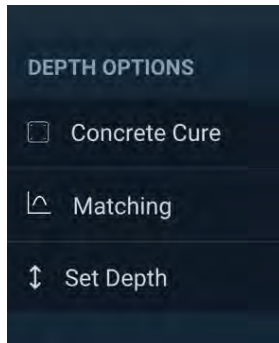

The Depth Panel provides three options for adjusting the dielectric constant and thereby refining your depth readings. From least accurate to most accurate, the choices are Concrete Cure, Matching, and Set Depth.

Concrete Cure applies a predefined dielectric based on established values. This can be an accurate method, but it relies on knowledge of the state of concrete curing.

Matching involves fitting a digital hyperbola to a target in your data. This is an accurate and widely used method for calibrating the depth scale.

Set Depth is the most accurate method, but it requires a physical measurement of the depth of a target. This information is not always available, so Matching will likely be a more appropriate choice.

Depth Panel: Concrete Cure

Concrete Cure is the simplest, yet least accurate method for calibrating the depth scale. You will be prompted to select Concrete Cure when starting a new 2D scan from the Main Dashboard or Project Profile screens. Use your knowledge of the age and condition of the concrete to inform your decision. Select a Concrete Cure by using preset dielectric values based on four standard concrete curing stages: Very Dry, Moderately Dry, Damp, and Wet.

Using one of the preset Concrete Cure types will only adjust your depth scale; it will not affect the GPR data quality. In the images below, note how a change in Concrete Cure Type expands the depth scale but does not visibly alter the GPR data.



We recommend starting with Moderately Dry (6.25 dielectric) for most concrete types. However, not all concrete slabs are the same. Consider using the Matching tool (Page 56) if you cannot readily determine the concrete curing state. Once an accurate dielectric is established, the targets in the slab will be displayed with a more accurate depth. We recommend using the Depth Panel options any time you are scanning a new slab.

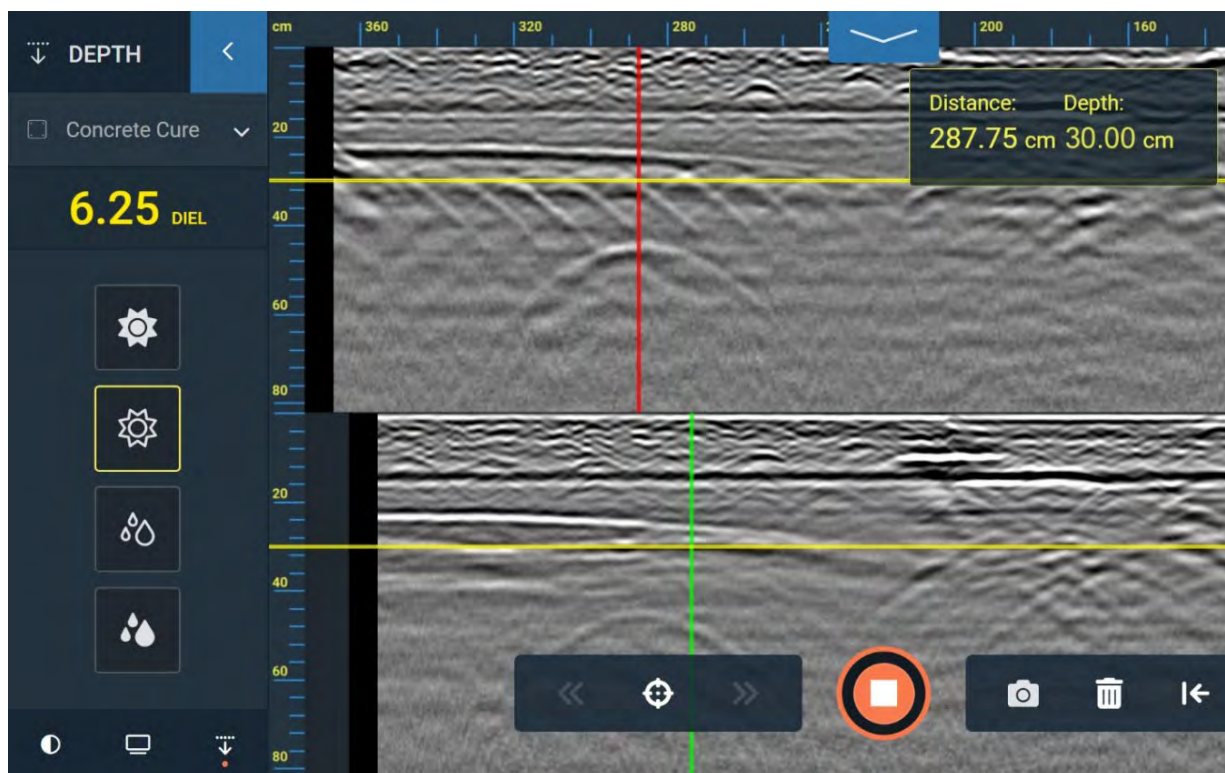

Concrete Cure set to Moderate Dry. The yellow cursor is placed at 30.00 cm below the surface.

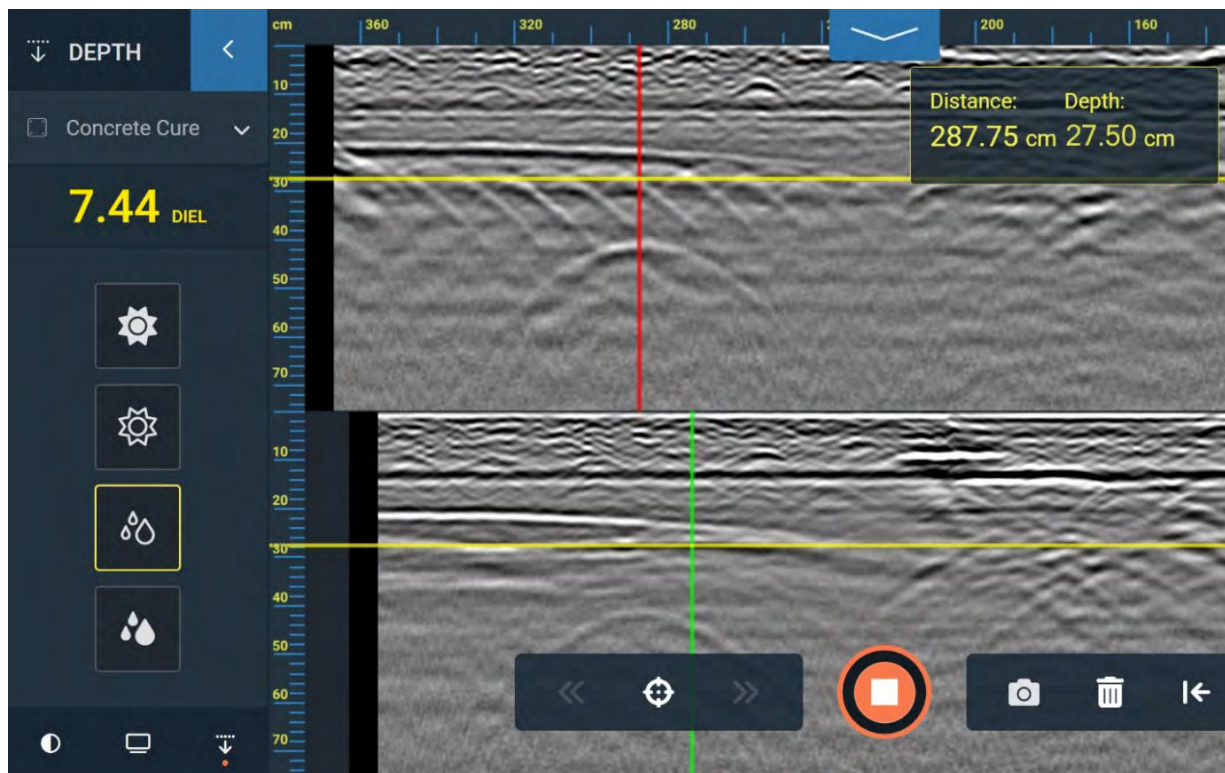

Concrete Cure set to Damp. The yellow cursor is now located at 27.50 cm below the surface. The GPR data have not changed, but the depth scale has been updated.

As the dielectric value increases, the calculated depth of targets becomes progressively shallower. This effect is due to the slowing of the GPR wave in higher dielectrics. For example, using a dielectric of 4.59 (Very Dry) a target is observed at 35 cm deep. Changing the dielectric to 6.25 (Moderate Dry) changes the target's depth to 30 cm. Dielectric values of 7.44 (Damp) and 14.10 (Wet) reduce the target's calibrated depth to 27.5 cm and 20 cm, respectively.

The takeaway point is that the dielectric value can dramatically change the depth reading for a given target. The target itself is not changing its true depth, but Flex NX is using the available information to calibrate its depth scale. A more refined dielectric value will greatly improve the overall depth accuracy, leading to improved markouts and increasing safety for cutting, coring, and drilling teams. Selecting a Concrete Cure Type is a good first step, but it should always be followed by Matching and Set Depth (when possible).



GPR effectiveness improves as concrete continues to cure. GPR depth and data quality are reduced when scanning green (uncured) concrete due to enhanced electrical conductivity.

Depth Panel: Matching (Hyperbola Fitting)

Improve the depth accuracy of targets by using the Matching tool. For best Matching results, we recommend using the standard antenna in single channel mode.

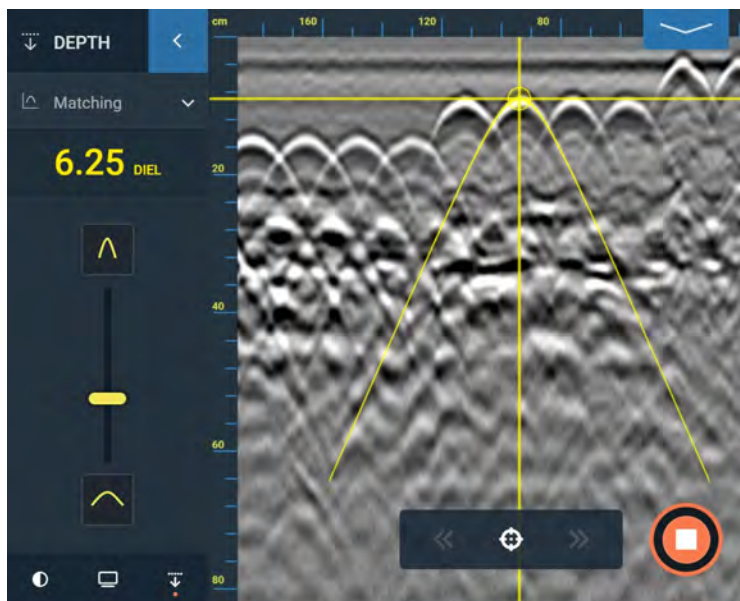

During collection, locate a hyperbola in your profile. It must represent a target scanned perpendicular to its length. If you are unsure whether you are scanning perpendicular to the object, scan it at multiple angles and find the scan angle that produces the narrowest hyperbola. This is the perpendicular scan.

Alternatively, locate a target and mark it on the slab. Collect an adjacent scan and mark the target again, then draw a line between the marks. Use this method to accurately determine a target's orientation.

To use the Matching tool, use your finger to position the crosshair and the digital hyperbola overlay at the peak of the first brightest band of color. Use the O-Scope (see Display Panel) to assist with placement.

Use the vertical slider to narrow or widen the hyperbola overlay. As you reshape the hyperbola the dielectric value and depth scale will update in response. Match the shape of the hyperbola overlay to the tails of the target hyperbola. Target depths will now be more accurate.



Use the Matching tool on multiple hyperbolas to check your accuracy. If your results are inconsistent, you have likely crossed targets at an incorrect angle. In other cases, using Matching on a shallow target with a large diameter could skew the depth scale.

Depth Panel: Set Depth

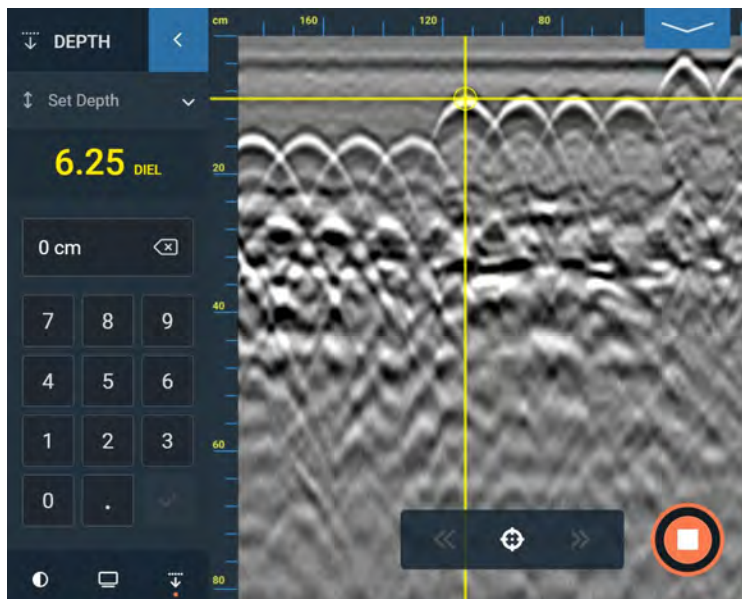

For homogenous materials, like most concrete, you can greatly improve depth accuracy by using the Set Depth tool. For best results, use only the standard orientation antenna in single channel mode. In some situations, the true depth of a target can be determined through drilling or observation of slab edges.

To use this feature, scan over a target with an established depth. Collect enough data on either side of the target to fully image the resulting hyperbola.

Use your finger to tap the screen, then drag the crosshair to the top center of the hyperbola. Align the cursor with the first strongest band of color; this band corresponds with the top of the target. Use the O-Scope to assist with cursor placement.

Using the number pad, type in the known depth of the target. This process will update the dielectric and calibrate the depth scale. Target depths will now be more accurate, especially in homogenous concrete.



The Set Depth tool is only applicable to a target of a known depth; it will not be useful in all cases. Avoid entering a depth based on assumptions or guesses. When in doubt, use the Matching tool instead of Set Depth.

Target Marking

Use the Target Marking feature to place user marks in your data. These points will assist in marking, referencing, or plotting the distance along the profile and depth below surface of features of interest. Consider using specific colors for target interpretations. Your on-screen marks will appear in screengrabs and can be useful additions to project Results.

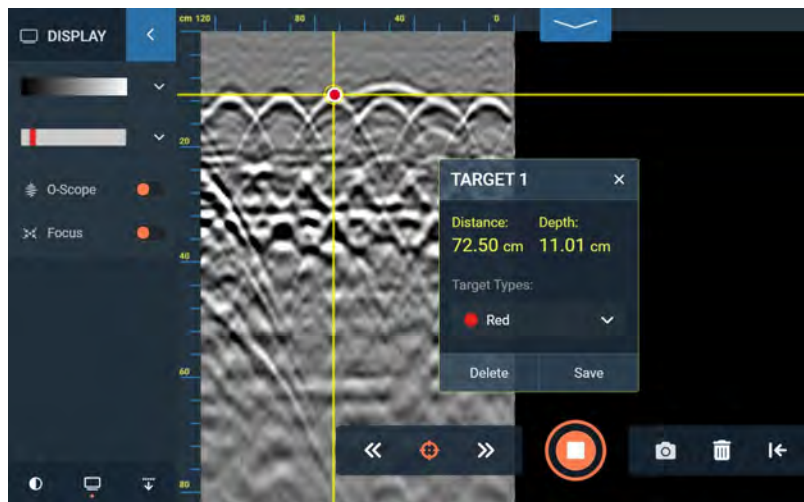

Target Marking Icons

Disabled



Enabled



To mark a target, activate Target Marking by tapping the Target Marking icon. Tap the screen and then drag your finger to place the crosshair over a target of interest. As with other target-related functions, like Matching and Set Depth, place the crosshair at the center of the hyperbola and within the first strongest color band. Use the O-Scope to fine-tune crosshair placement.

In the accompanying popup window you'll see the target's distance along the profile and its depth. Note that the depth reading is only as accurate as the current dielectric value. If in doubt, use Matching or Set Depth (where applicable) to refine the dielectric and improve depth accuracy. Reposition the popup window by tapping and holding with one finger, then moving your finger to drag the window.

You can also select a target color from the dropdown menu. We recommend using designated colors for specific target types, such as red for conduit and blue for reinforcement. Press Save to place the mark or Delete to discard it.



Use the Previous Target / Next Target icons (found on the Bottom Navigation Bar) to quickly jump between multiple targets within a single scan.



In the System Settings screen, try assigning the Mark function to one of the Flex NX or NX25 programmable buttons. Using the assigned Mark button during 2D collection will place a dotted vertical line in your data, but it will not place discrete target marks.

Additional Resources

GSSI Academy Training



When pursuing mastery of concrete scanning there is no substitute for experience. Whether you are about to collect your first scan or your 100th, improving your knowledge of GPR is always time well spent.

Training and dedication are the keys to success, and our GSSI Academy classes are designed with all experience levels in mind.

We highly recommend enrolling in one of our live Flex NX classes at GSSI headquarters in Nashua, NH or our training location in Henderson, NV. If you can't get to a class right away, or you've already completed a class and want more information, this User Guide provides guidance for scanning and identifying concrete reinforcement scenarios and other concrete-related targets like post-tensioned cables and air voids beneath slabs. These data may or may not be already loaded onto your Flex NX, depending on your software version. The following discussion will walk you through selected concrete data examples, provide information on construction techniques, and offer tips to improve your scanning experience.

Need more information? You can visit our Flex NX support site by scanning the QR code on Flex NX's Technical Support Panel or by visiting us at www.geophysical.com/support/FlexNXsupport. You can then download or share a PDF of this User Guide, browse other Flex NX documentation, access video tutorials, and download the latest Flex NX software.

Scanning and Marking Best Practices

There is a wide variety of objects that may be present in a concrete slab, including reinforcement, conduits, post-tensioned and pre-tensioned cables, and other elements of slab construction. An exhaustive list is beyond the scope of this document but see below for an introduction to the basics of scanning concrete and identifying targets within and just below the slab.

Basic Scan and Mark Techniques

We recommend collecting as much data as possible to ensure you are making the most informed decision. When starting a scan, take a long scan of the area to get an idea of the general reinforcement and utility layout.

To mark a target on the slab, or on a data collection grid sheet, scan over and past it and roll the antenna backwards until the cursor is centered on the peak of the hyperbola. To avoid error, don't scan too far past the object, as you may not roll the antenna backward along the same path. Place a small mark on either side of the antenna, both at the same distance from the antenna, using the sides lasers on the antenna you are aligning with the target. Move the antenna and place a final mark in the direct center of the two small marks, or move the antenna backwards until the front

laser is centered between the two small marks. Try using a ruler or another straight edge to draw straighter lines.

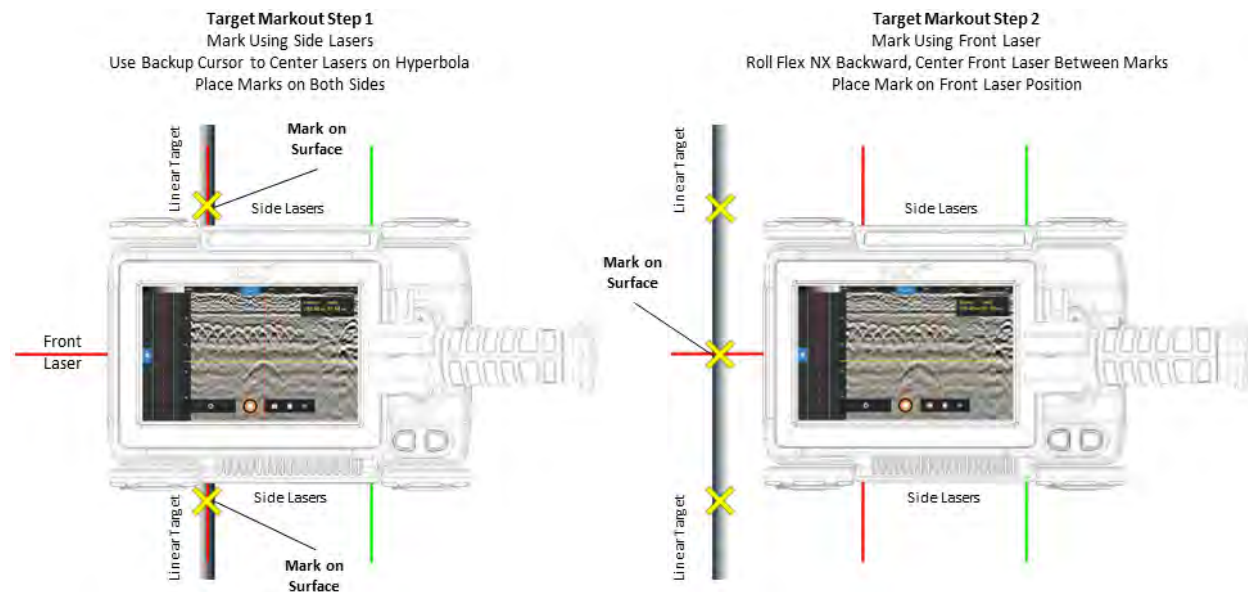

This process results in a mark directly where the center of the antenna was when it crossed the center of the target. Repeat this process until you have at least three marks representing the object (if it is a linear object) and draw or mark out the object on the slab or grid sheet in accordance with [CSDA-BP-017](#), the Concrete Sawing and Drilling Association's best practices document on properly marking GPR findings.

Reinforcement should be marked in black (or a non-red color if black is not appropriate for the surface) using a permanent marker or wood crayon. Conduit should be marked in red, or another color if appropriate, but never mark conduit with the same color that you use to mark reinforcement. Mark at least a 1" exclusion zone on either side of the center point of the object, as GPR cannot reliably determine the size or width of embedded objects. If the object is much wider than this, such as a beam or duct bank, mark an exclusion zone of at least 1" beyond either end of the object. If the object is not travelling in a straight line, mark as many locations as necessary to properly capture its path of travel through your scan area. The owner or contracting agency should mark the extents of your scan area, though you might have to mark them if it is not done for you. If the scan area is free of embedded objects, mark "OK" within the scan area.

Keep in mind that you need direct access to the concrete slab in order to scan. Insulating foam, waterproofing plastic, wood, or an air gap between the antenna and the top of the slab will all reduce depth penetration and data quality. These and other covering materials should be removed by the owner/contractor before you arrive. Standing water on the surface of the slab will also reduce the effectiveness of GPR.

See the CSDA best practices document available at csda.org for further details on properly marking GPR findings.

Data Examples

We have compiled Flex NX data examples covering some common concrete scanning scenarios. Depending on your software version, your Flex NX system may or may not have data examples preloaded.



GSSI does not recommend scanning green (freshly poured) or uncured concrete. The conductivity of immature concrete dissipates the GPR energy, resulting in greatly reduced depth penetration and data quality.



DISCLAIMER: Your data may look different from the examples featured below. The following examples are no substitute for knowledge and experience and they do not represent all conditions and scenarios. Please use your best judgment when scanning.

Wire Mesh

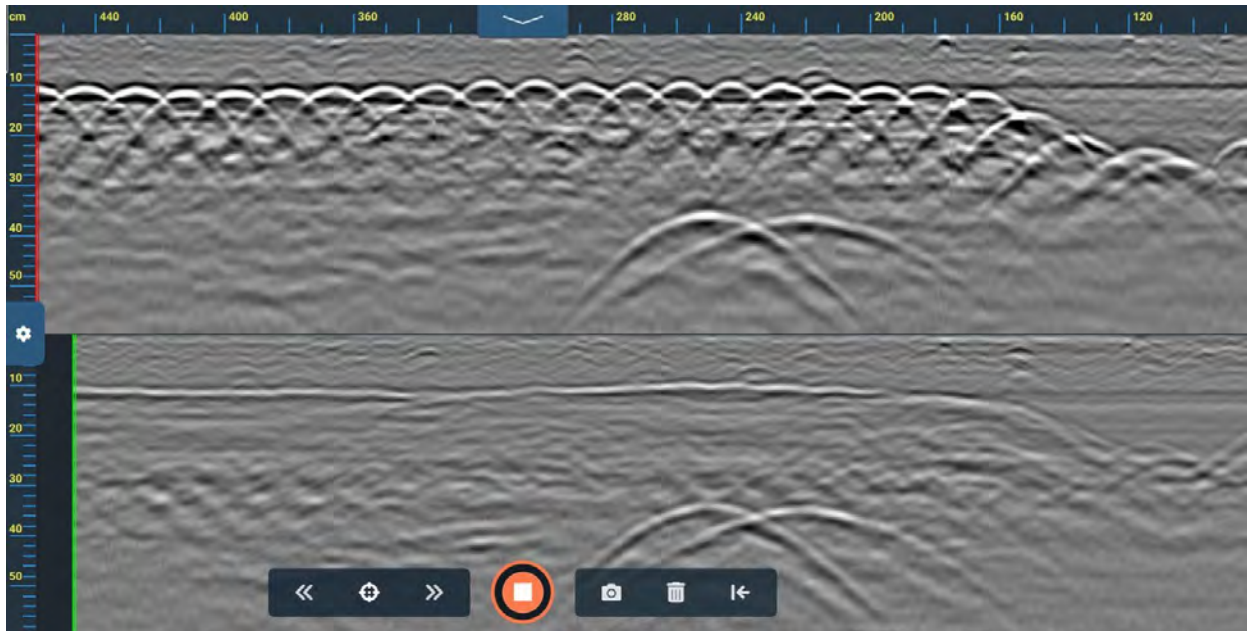

Wire mesh, located near the top of the profiles. Note the following features:

- Dipping mesh at far right of the profiles.
- Close spacing of targets. The hyperbolic tails overlap due to the close spacing.
- The presence of two deeper and wider hyperbolas in the middle of the profiles.
- The standard antenna (top profile) shows abundant and shallow hyperbolas from wire mesh. These hyperbolas appear as a flat layer in the cross-polarized (bottom) profile.

Wire mesh is a metal mesh made by welding small-gauge wire into square or rectangular patterns. The mesh provides reinforcement to concrete slabs and prevents cracking. It is often placed into the slab just before the concrete is poured and is usually the shallowest object in the slab.

Mesh often retains some curvature when unrolled because it is stored and transported in tightly wrapped cylindrical bales. For this reason, the wire mesh in the slab may rise or sink at the ends of each mat. The entire mat may also deform under the weight of poured concrete, leading to the mat sinking deeper into the slab in some areas and rising to a shallower depth in others. When one roll of wire mesh runs out, workers will overlap it with the next roll. As a result, in some locations you may find areas containing double mesh layers.

A wire mesh signature is like a small-size rebar mat. The GPR data will contain consistently spaced hyperbolic reflections from individual wires. While rebar is installed in the slab by hand and can have inconsistent spacing between each bar, wire mesh is a factory-made, prefabricated roll. This means that the spacing is perfectly consistent. When scanned with a cross polarized antenna, mesh appears as a flat reflector with the hyperbolas merged into a continuous line.

Wire mesh with smaller spacing or closely spaced rebar may prevent or greatly inhibit GPR penetration. Conversely, mesh with a larger spacing, or wider spaced rebar, may allow for deeper penetration. Targets under mesh or rebar may be more difficult to identify. Utilizing the cross-polarized antenna will remove, or at least reduce the impact of, the tails from the wire mesh hyperbolas. This makes it easier to image and interpret deeper targets. Similarly, cross-polarization will reduce the length of the 'tails' of the hyperbolas created by rebar reflections, as well as reducing the amplitudes of metal targets, which can aid in visualizing non-metallic objects beneath upper layers of reinforcement.

Rebar

Steel reinforcing bars (rebar) are, along with wire mesh, the most common targets in concrete structures. They are often the primary reinforcement for a slab, and typically run in two perpendicular directions. In thicker slabs, or in slabs that will support considerable weight, there may be two layers of rebar: one closer to the top of the slab and one closer to the bottom. When oriented perpendicular to the survey line they produce clean and strong hyperbolas with long tails and are especially apparent in profiles from the standard antenna. The amplitude (signal strength) of rebar reflections increases with rebar diameter, though it is not possible to determine rebar size. Rebar will still create a hyperbola when scanned in cross polarized orientation, but it will have lower amplitude and will be less expansive.

Rebar is used in most concrete structures, not just floor slabs. Rebar is typically present in jersey barriers, beams, retaining walls, above ground storage tanks constructed with concrete, columns, and any other concrete structures that require reinforcement. Rebar is also used when connecting a new section of concrete to an old section. These 'dowels' are short pieces of rebar and can be identified by scanning along the top to confirm their length, which can be as little as one foot. Check the surface of the slab for evidence of different aged sections of concrete, or obvious seams or saw cuts, which may suggest the presence of dowels used for patching, repair, or additions.

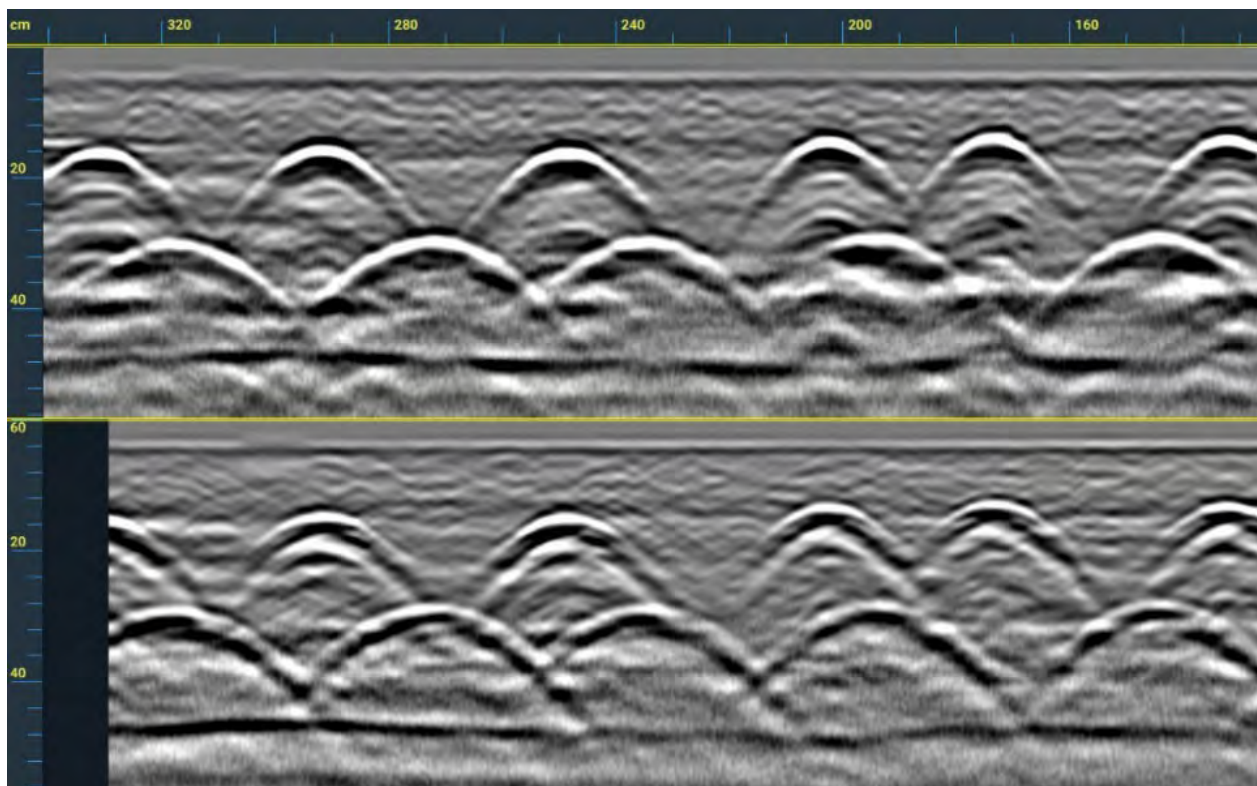

Top and bottom layer of rebar. Due to the increased width of the GPR's cone of energy, the lower rebar layer produces wider hyperbolas. The slab bottom is more easily seen in the cross polarized data, at a depth of 48 cm.

Conduit

Conduit refers to hollow, metallic, or non-metallic pipe installed inside a slab. It is one of the most important targets to precisely locate, as it can contain live power lines or data cables. It may be placed into the slab prior to the concrete pouring. Alternatively, it could be installed in a trench cut into cured concrete which is then backfilled with fresh concrete. A threading wire is used to pull power or data cables into and through the empty conduit. When placed prior to concrete pouring, a conduit may be tied directly to or underneath rebar which can increase the difficulty of locating it. Buildings are constructed with extra conduits for future expansion and renovation, so some conduits may be empty even in an active building.

Steel conduit may appear identical to steel rebar of the same diameter, though rebar will exhibit a more predictable layout pattern. GPR energy does not penetrate metal, so there is no difference between reflections from a solid rod or a hollow metal pipe. In GPR profiles a large diameter conduit, duct, or pipe (over 2in or 5cm) will, relative to smaller diameter objects, produce a hyperbola that is noticeably larger. However, despite relative differences in hyperbola size the diameter of targets is not discernable with GPR. A non-metallic conduit will have a lower amplitude reflection and is more likely to change depth within the slab, bend side-to-side, or change directions and may be easier to identify on cross-polarized profiles.



Conduit located beneath a wire mesh layer. The wire mesh hyperbolas disappear in the cross-polarized data, becoming a coherent layer and further revealing the conduit beneath.

Pan Decking

Pan decking is a corrugated metal sheet supporting concrete slabs. The concrete is poured onto the decking, providing strength and durability to the slab above. Pan deck slabs will usually only contain wire mesh without rebar, as the decking itself provides most of the reinforcement. Conduits may be installed in the decking's bottom flanges (troughs) prior to pouring the concrete. The decking will create complex reflections at the flange shoulders that typically obscure targets set into the bottom flanges, creating a challenging environment for GPR. Try using the cross-polarized channel to reduce the impact of hyperbolas. In addition, consider using Focus Mode for a different and complimentary view of the data. In Focus Mode, the conduits in bottom troughs, or along the sloping sides, could appear as discrete dots against the continuous surface of the decking.

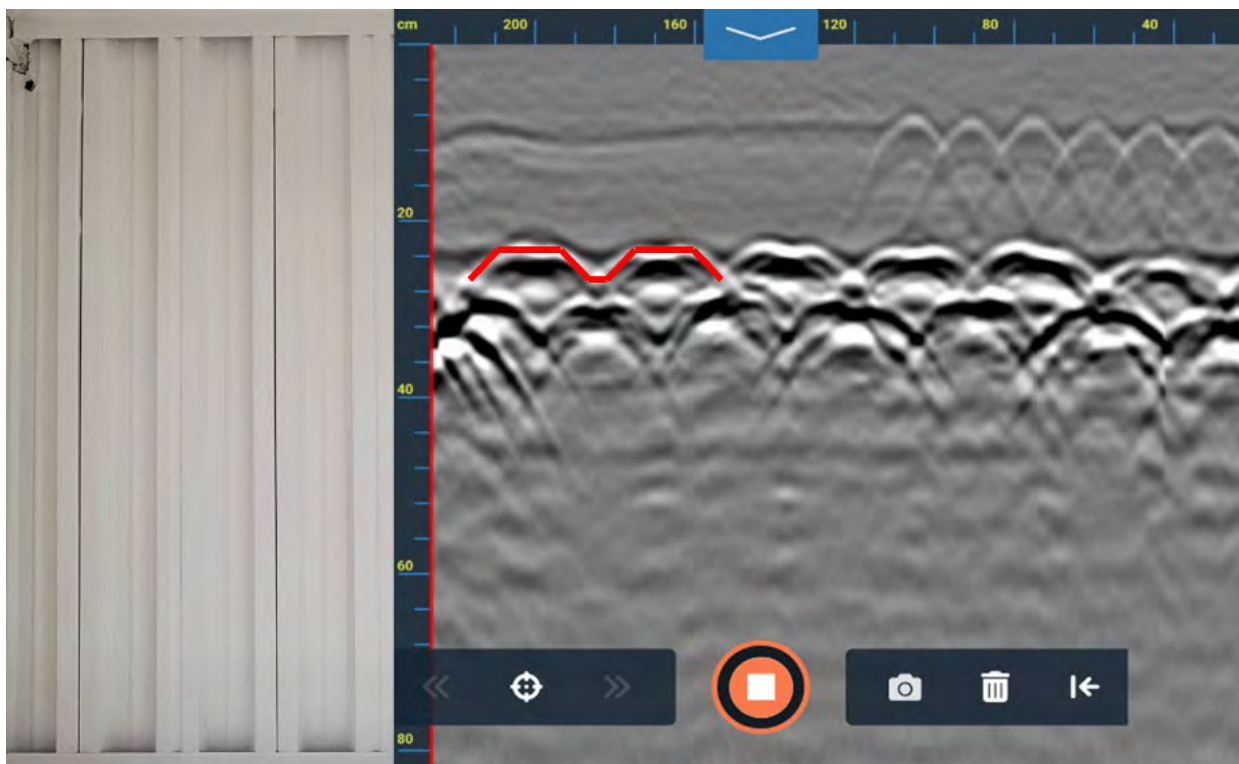

Left: View of pan decking from below. **Right:** pan decking running across the center of a GPR profile. The metal sheet alternates between higher and lower flanges and is visibly similar to the cross section of cardboard (red line overlay). Top flanges are resolved as elongated hyperbolas; bottom flanges (troughs) appear offset below as hyperbolas. The bottom flanges may have conduit installed within them. The shoulders of the top flanges and sloping sides generate reflections, often preventing radar from 'seeing' into the low points.

Beams and Objects Strapped to the Slab

Many concrete slabs have metal beams directly beneath them, and the beams may or may not be tied into the slab using vertical metal fastenings. Stud anchors and channel anchors are two such examples. It will not be possible to image beams below pan decking because the radar wave will not pass through the metal deck. If the beam is directly below the concrete it will present as a strong, flat, wide hyperbola at or just below the depth of the slab bottom.

Similarly, conduit or anchors may be attached directly to the bottom of a concrete slab. In this case, you will see a hyperbola – smaller than the hyperbola created by a beam – at or just below the depth of the slab bottom. It can be difficult to see objects strapped to the bottom of a very thick slab, as the radar wave must travel to the bottom of the slab and back, losing signal strength along the way.

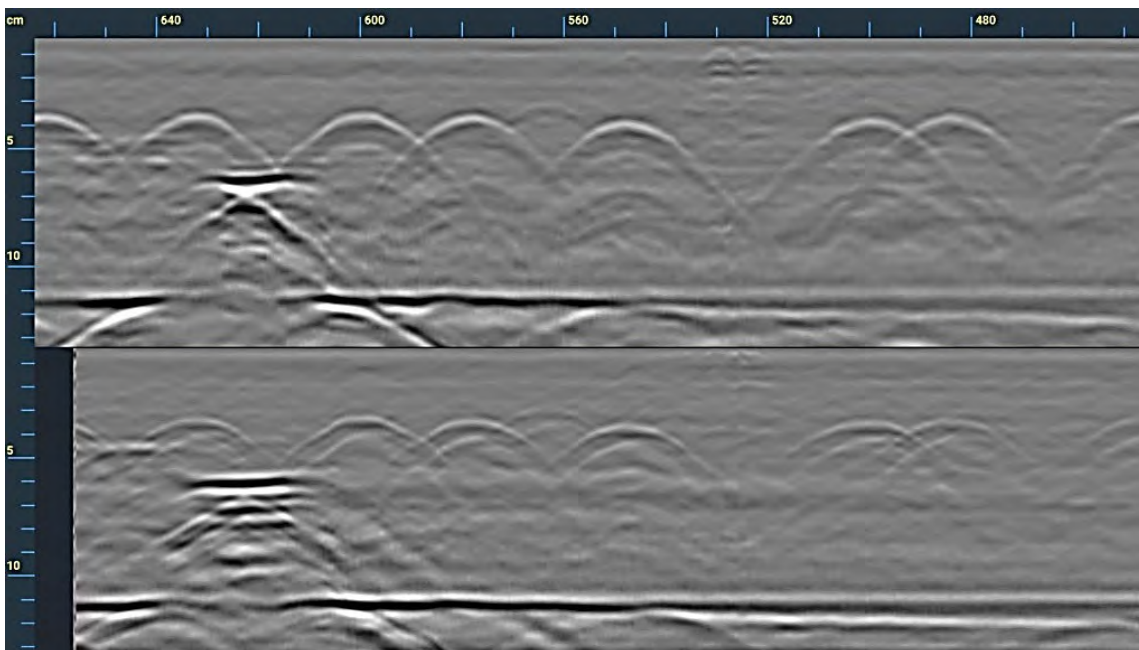

An I-beam in a wall observable as a flat, planar reflection at a depth of 6.5 cm. The other side of the wall appears as a planar reflection at a depth of 11.5 cm. The hyperbolas underneath this layer represent conduits strapped to the other side of the wall.

PVC vs. Metal Targets

A Polyvinyl Chloride (PVC) pipe or non-metallic conduit in concrete generally produces a low amplitude hyperbola of the same shape as hyperbolas from metal targets. PVC is nearly transparent to GPR, so targets inside or underneath a PVC pipe can still be visible. This means that we do not directly detect the PVC pipe; we detect the air, water, or other substance inside it.

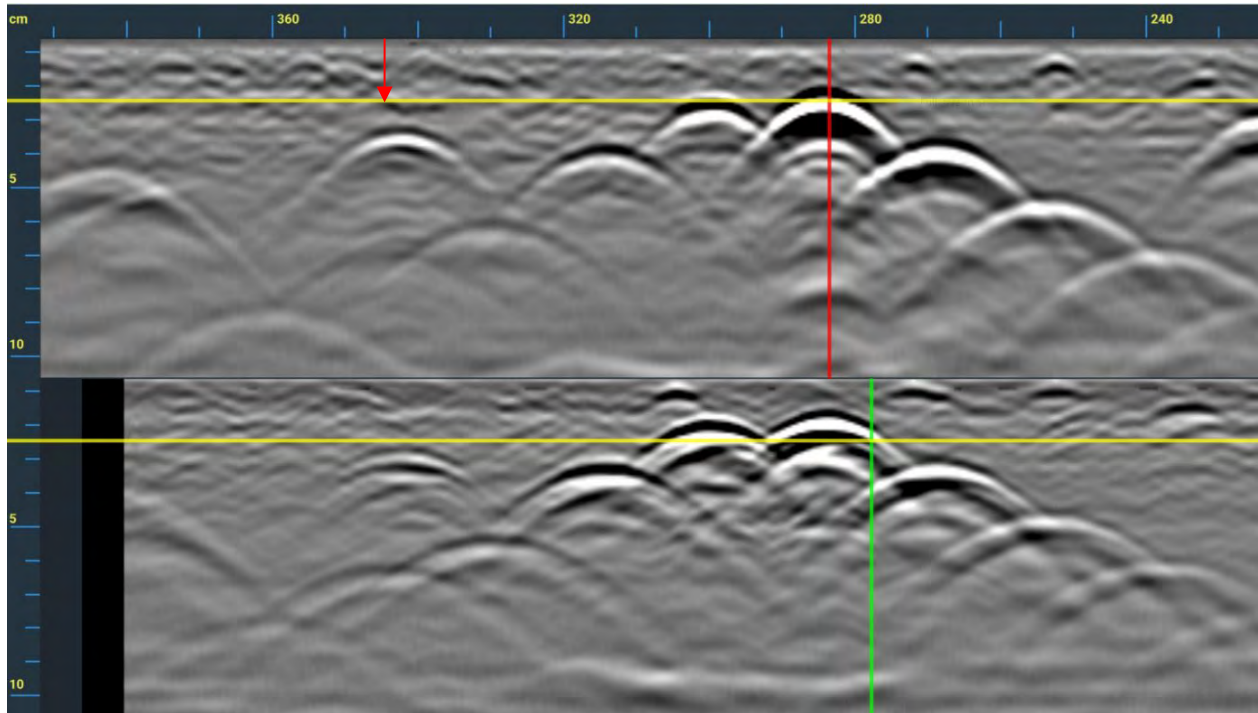

Rebar located on the right side of the profile, visible as high amplitude hyperbolas. PVC targets are located on the left side of the profile, exhibiting lower amplitude hyperbolas compared to their metal counterparts. A single rebar on the left side (red arrow) obscures two conduits beneath it. The PVC pipes are more easily detectable in the cross polarized channel due to the antenna's lower sensitivity to metallic targets. Hyperbolas in the cross polarized data are less expansive, making it easier to see deeper targets.

Air Voids Under Concrete Slabs

Voids in concrete, either air or water filled, produce observable targets when small and continuous layers when large and expansive. An air-filled void below concrete will produce a moderately strong, black-white-black reflection pattern. Air voids exhibit a higher GPR velocity than concrete, causing the GPR energy to accelerate and reverse phase/polarity at the concrete/air boundary. In contrast, the slab/grade contact will often appear as a white-black-white reflection pattern because the GPR energy decelerates at the slab/grade contact (assuming typical water content in the grade materials). It is difficult to distinguish between the slab/grade contact and water-filled void spaces. Both should produce the same reflection pattern, though water-filled cavities should produce a higher amplitude reflection and will likely manifest as a more complex layer reflection.

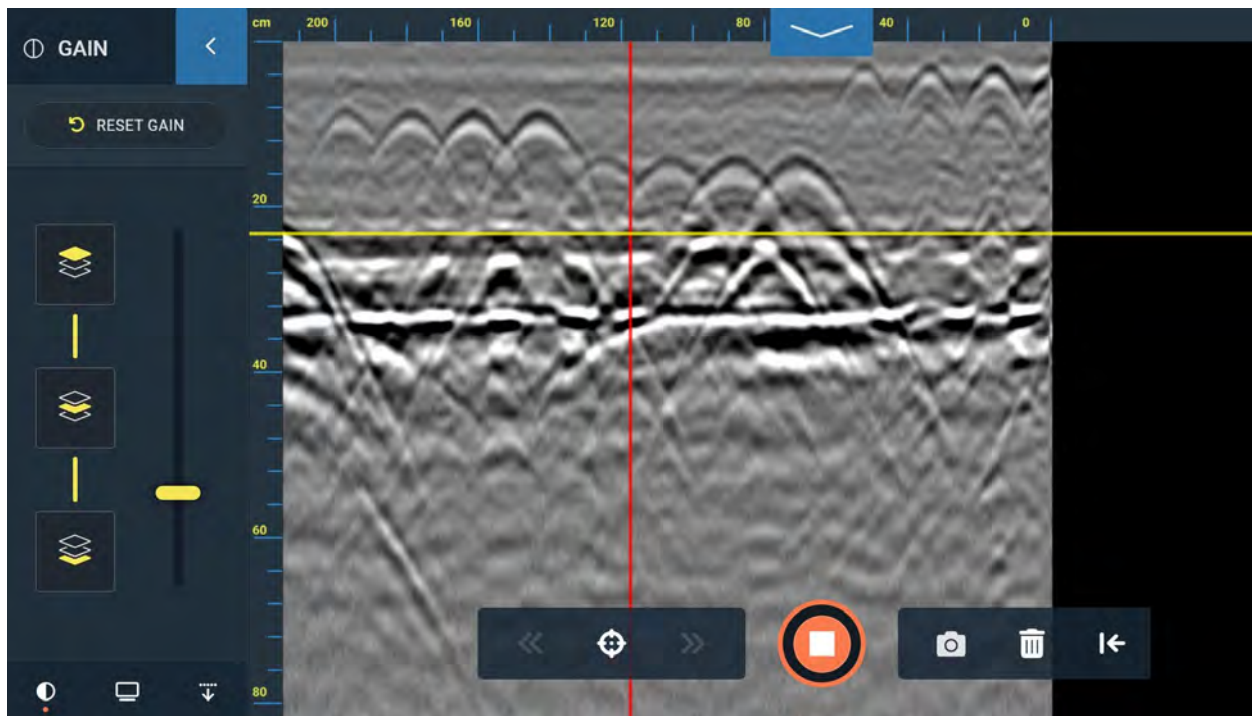

Air filled PVC pipes and small voids in concrete appear as hyperbolas, and in most cases they produce low amplitude reflections with black as the first strongest band of color. Larger air voids appear as continuous or discontinuous layers with black as the first-biggest-brightest reflection. Use the O-Scope to assist with these determinations.

Multiple Reinforcement Layers

In structures with two layers of rebar, visibility of the second layer depends on the bar spacing in the first layer, slab thickness, and the amount of attenuation and scattering in the concrete. Staggered rebar are more likely to be visible, whereas a deeper layer of rebar set parallel to the top layer will be much less visible. If you have access to the bottom of a thick slab you can scan from below to mark deeper targets more easily.

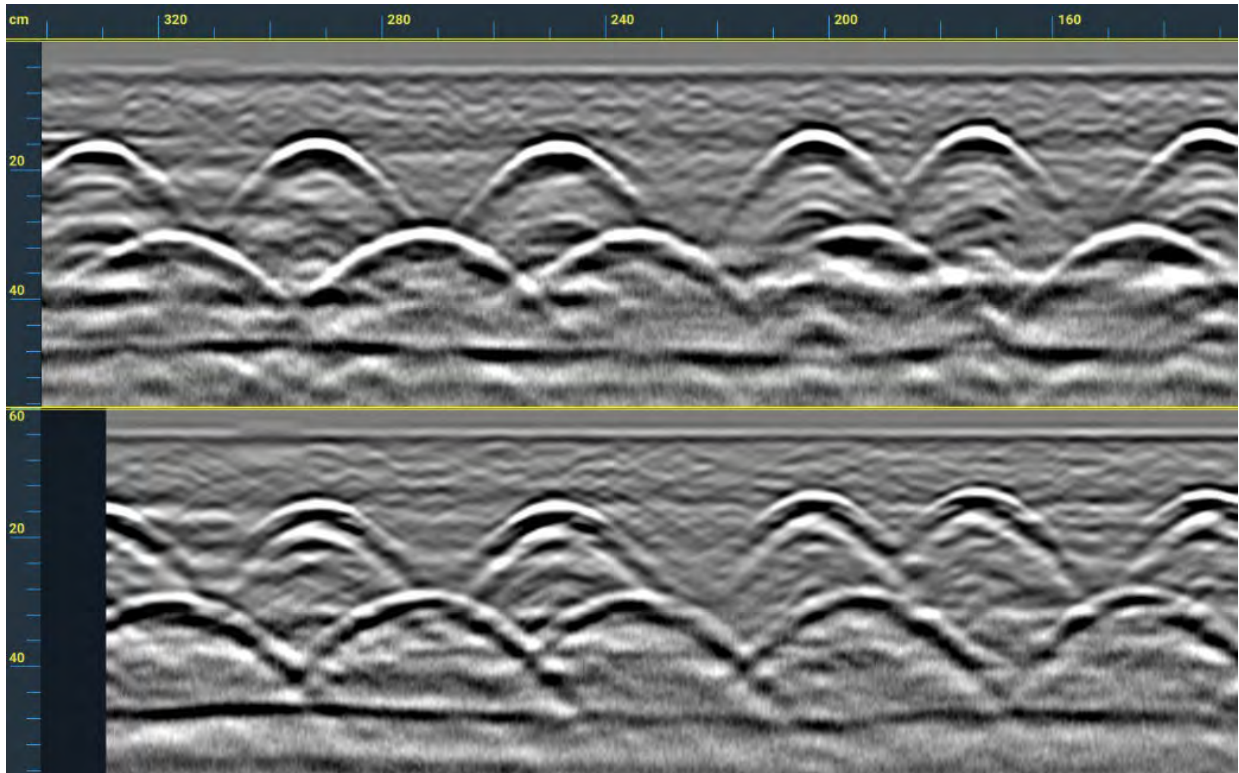

Two closely spaced layers of rebar. The lower rebar layer is often obscured by the top layer, usually resulting in incomplete or misshapen hyperbolas.

The cross-polarized channel (lower profile) reveals a more defined slab/grade contact.

PT Cables

Steel post-tensioned (PT) cables are present in some structures along with reinforcing bars. The cable strands are housed in sleeves and are ratcheted to a high tension after the concrete has been poured, increasing the strength of the slab. Any damage to the PT from cutting, sawing, or coring could cause catastrophic failure, leading to loss of life and severe infrastructure damage. The cables are often laid in a fan pattern, where multiple cables are spread apart at either end of a slab and they move closer together toward the middle of the slab. They also change depth within the slab, rising and falling across the span and often ranging in depth from shallow on the sides to deeper in the middle.

Their typical appearance in a GPR profile is comparable to rebar. An uncoated steel cable and a rebar of the same size would produce identical hyperbolas. In practice, PT cables are placed into plastic conduits and/or coated with plastic, which may affect their reflection amplitude. When compared with rebar, PT cables may produce a weaker reflection on cross-polarized antennas. This, combined with the unique way that the cables are routed within the slab, allows for easier identification. PT cables show why it is important to collect long scans and understand the broader patterns around your target areas. Scanning at multiple locations could identify the changes in PT spacing and depth, and scanning along the top of potential PT cables will reveal if targets are rising and falling in the slab. In some cases, such as post-tensioned tennis courts, the PT cables will neither fan out nor change depth within the slab and may appear very similar to rebar or conduit.

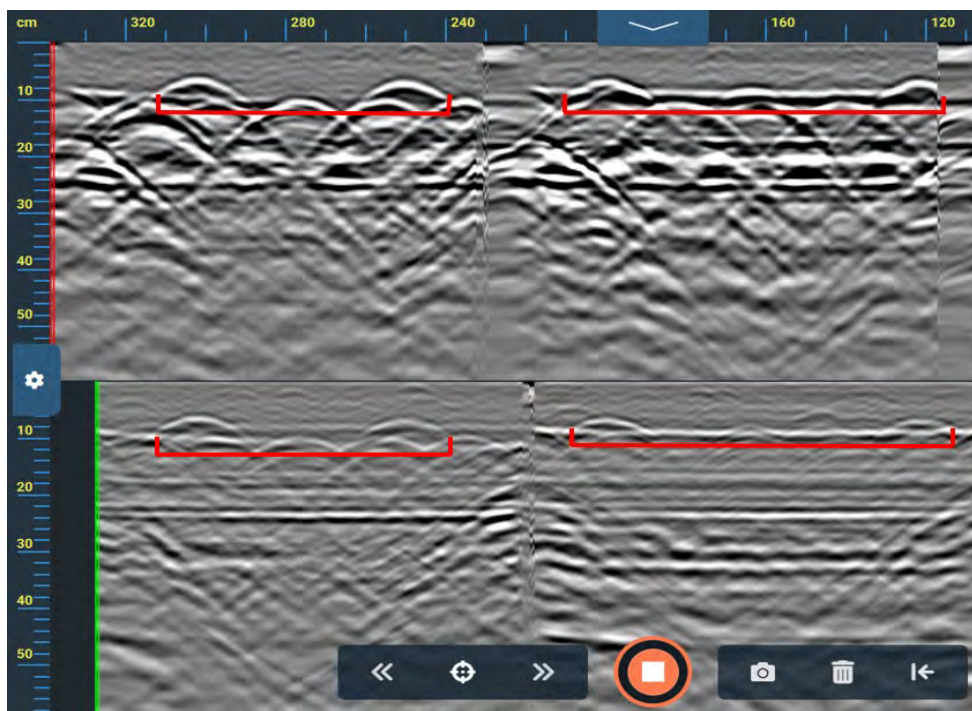

Post-tensioned cables crossing a rebar mat at 45° angles. PT cables are visible in both standard and cross-polarized channels. Note the much lower amplitude and greater clarity of the cross-polarized profile, where the hyperbolas from the PT cable are much more obvious.

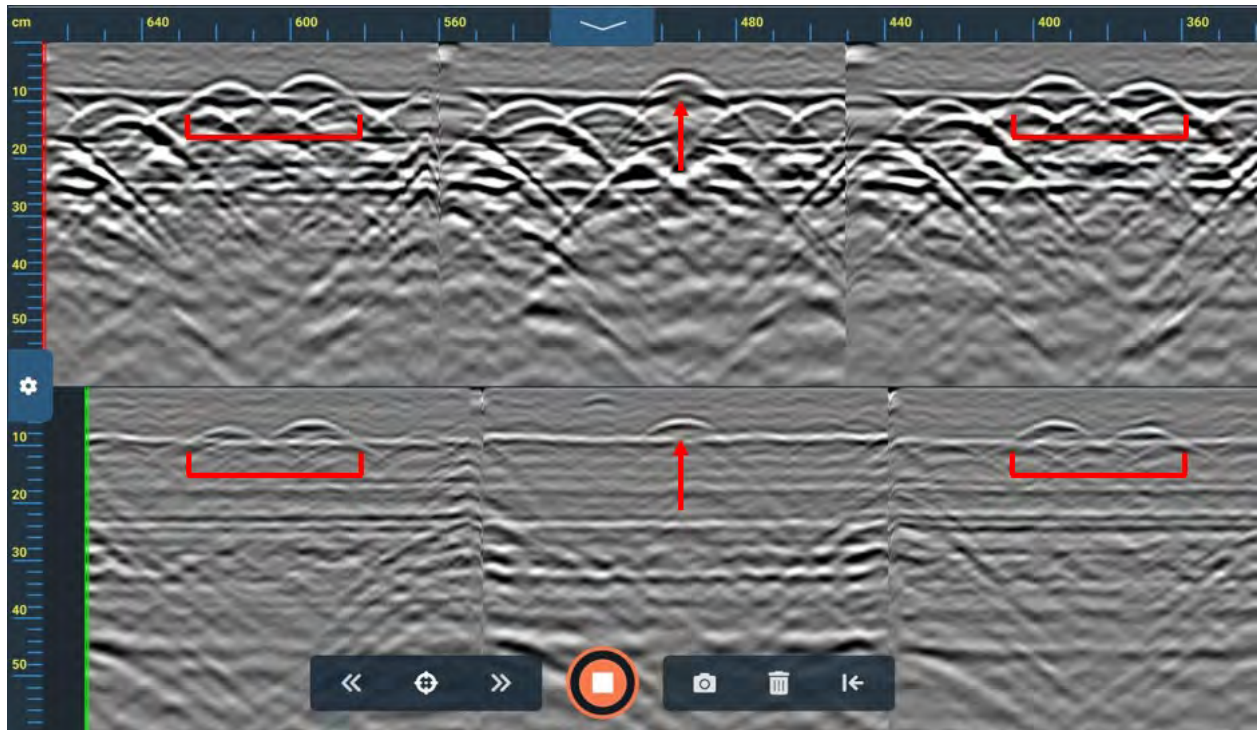

A post-tensioned cable positioned above a rebar mat. In this example the PT cables converge until they 'cross' over, then they diverge further along the profile. These data were collected using a single file number, and the Flex NX was moved to adjacent locations to track PT cable layout.